

B09B**DISPOSAL OF SOLID WASTE****Definition statement**

This place covers:

Only single or combined, e.g. multistage, operations not fully classifiable in a single other subclass

References**Informative references**

Attention is drawn to the following places, which may be of interest for search:

Obtaining proteins from waste water of starch manufacturing plants of like wastes	A23J 1/16
Animal feeding-stuffs from kitchen waste	A23K 10/10
Animal feeding-stuffs from waste products of dairy plants	A23K 10/28
Animal feeding-stuffs from distillers' or brewers' waste	A23K 10/38
Footwear made of rubber waste	A43B 1/12
Disinfection or sterilisation methods specially adapted for refuse	A61L 11/00
Chemical means for combatting harmful chemical agents; processes for making harmful chemical agents harmless	A62D 3/00
Chemical purification of smoke or fumes, e.g. flue gas	B01D 53/34
Disintegrating by knives or other cutting or tearing members, which chop material into fragments, specially adapted for disintegrating garbage, waste or sewage	B02C18/40
Combinations of wet processes or apparatus with other processes or apparatus, e.g. for dressing ores or garbage	B03B 7/00
General arrangement of separating plant, e.g. flow sheets, specially adapted for refuse	B03B 9/06
Control of spray area of spraying plant, e.g. masking, side shields; Means for collection or re-use of excess material	B05B 12/16 , B05B 12/32
Prevent escape of dirt or fumes from the area where they are produced; Collecting or removing dirt or fumes from that area	B08B 15/00
Machines or arrangements for shearing stock while the latter is travelling otherwise than in the direction of the cut without regard to the exact dimensions of the resulting material, e.g. for cutting up scrap	B23D 25/14
Edge trimming saw blades or tools combined with means to disintegrate waste	B27B 33/20
Recovery of plastics or other constituents of waste material containing plastics	B29B 17/00
Presses for consolidating scrap metal or for compacting used cars	B30B 9/32
Refuse discharge from vessels, e.g. for ash	B63B 17/06
Arrangements of installation for treating waste water or sewage on vessels	B63J 4/006
Refuse receptacles	B65F 1/00
Vehicles particularly adapted for collecting refuse	B65F 3/00

Gathering or removal of refuse otherwise than by receptacles or vehicles	B65F 5/00
Cleaning or disinfecting devices combined with refuse receptacles or refuse vehicles	B65F 7/00
Ingredients generally applicable to manufacture of glasses, glazes or vitreous enamels	C03C 1/00
Hydraulic cements from oil shales, residues or waste other than slag	C04B 7/24
Calcium sulfate cements from phosphogypsum or from waste, e.g. purification products of smoke	C04B 11/26
Waste materials or refuse used as fillers for mortars, concrete, artificial stone or the like	C04B 18/04
Waste inorganic materials used as active ingredients for mortars, concrete, artificial stone or the like	C04B 22/0006
Waste organic materials used as active ingredients for mortars, concrete, artificial stone or the like	C04B 24/001
Fertilisers made from household or town refuse	C05F 9/00
Recovery of waste materials of macromolecular substances	C08J 11/00
Compositions of reclaimed rubber	C08L 17/00
Destructive distillation, specially adapted for particular solid raw materials or solid raw materials in special form	C10B 53/00
Other processes not covered before; Features of destructive distillation processes in general	C10B 57/00
Production of liquid hydrocarbon mixtures from rubber or rubber waste	C10G 1/10
Solid fuels essentially based on sewage, house or town refuse	C10L 5/46
Solid fuels essentially based on industrial residues and waste materials	C10L 5/48
Working-up used lubricants based on mineral oils	C10M 175/02
Recovery of fats, fatty oils, or fatty acids from waste materials	C11B 13/00
Recovery of glycerol from a saponification liquor	C11D 19/00
Recovery of by-products	C12F 3/00
Recovery of alcohol from press residues or other waste material	C12F 3/08
Biochemical production of ethanol from waste	C12P 7/08
Workingup raw materials other than ores, e.g. scrap, to produce non-ferrous metals or compounds thereof	C22B 7/00
Obtaining zinc or zinc oxide from muffle furnace residues	C22B 19/28
Obtaining zinc or zinc oxide from metallic residues or scrap	C22B 19/30
Obtaining tin from scrap	C22B 25/06
Mechanical treatment of natural fibrous or filamentary material to obtain fibres or filaments, e.g. for spinning	D01B
Carbonising rags to recover animal fibres	D01C 5/00
Recovery of starting material, waste material or solvents during the manufacture of artificial filaments or the like	D01F 13/00
Disintegrating fibre-containing articles to obtain fibres for re-use	D01G 11/00
Arrangements for confining or removing dust, fly, or the like	D01H 11/00

Regeneration of used chemical baths used for dry-cleaning or washing fibres, fabrics or the like	D06L 1/10
Dry treatment of waste paper or rags for making paper or for the production of cellulose	D21B 1/08
Defibrating waste paper	D21B 1/32
Processes for obtaining cellulose by working-up waste paper	D21C 5/02
Regeneration of pulp liquors by wet combustion	D21C 11/14
Re-use of pulp-water in wet end machines for making continuous webs of paper	D21F 1/66
Waste products added to the pulp or used in paper-impregnating material	D21H 17/01
Sewers, Cesspools	E03F
Arrangements in building for the disposal of refuse	E04F 17/10
Combustion apparatus arrangements for burning uncombusted material from primary combustion	F23B 5/00
Consuming waste products by combustion	F23G
Removal or treatment of combustion products or combustion residues	F23J
Removing emulsion from waste photographic material	G03C 11/24
Apparatus or processes for salvaging material from electric cables	H01B 15/00
Reclaiming serviceable parts of waste cells or batteries	H01M 6/52
Reclaiming serviceable parts of waste accumulators	H01M 10/54

Glossary of terms

In this place, the following terms or expressions are used with the meaning indicated:

Disposal	discarding, e.g. dumping, or destroying of waste or its transformation into something useful or harmless;
Solid waste	ncludes waste which, although it has liquid content, is for practical purposes handled as solid

B09B 1/00

Dumping solid waste

Definition statement

This place covers:

Disposing of solid waste by means of dumping, either as bulk material or as discrete elements of stabilized and/or packaged waste. Dumping may be within underground cavities.

Example: US-A1-2003/053865

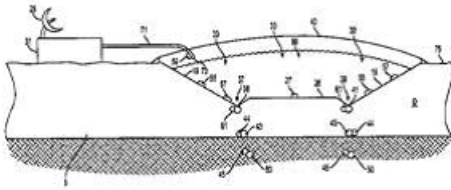

B09B 1/002

{Sea dumping (disposal of radioactively contaminated material by storage under water [G21F 9/24](#))}

Definition statement

This place covers:

Dumping solid waste on or into the seabed.

Example: BE-A5-1015677

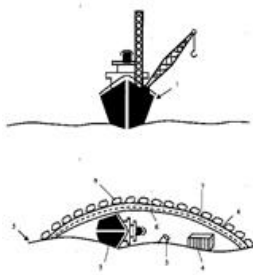

B09B 1/004

{Covering of dumping sites}

Definition statement

This place covers:

Covering dumped waste, the cover means being applied to the top surface of the dumped waste.

Example: US-A1-2002/067953

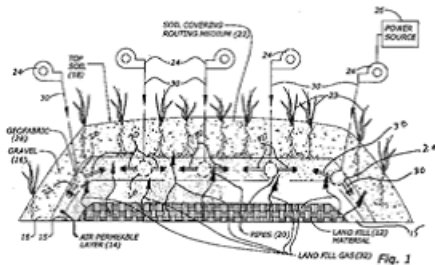

B09B 1/006**{Shafts or wells in waste dumps}****Definition statement***This place covers:*

Shafts or wells and providing these in waste dumps, the shafts or wells being manufactured before, during or after dumping the solid waste.

Example: DE-A-4312267

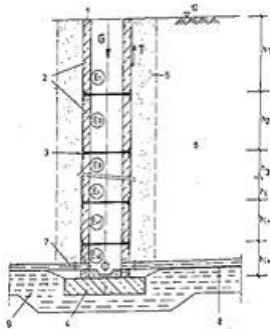
**B09B 3/00****Destroying solid waste or transforming solid waste {or contaminated solids} into something useful or harmless****Definition statement***This place covers:*

Destroying solid waste or transforming solid waste or contaminated solids into something useful or harmless, as long as this is not fully classifiable in a single other subclass.

B09B 3/0058**{Removing gases or liquids enclosed in discarded articles, e.g. aerosol cans, cooling systems of refrigerators (arrangements for charging or discharging refrigerant from refrigerators [F25B 45/00](#)); Removing gases from discarded plastic foam products}****Definition statement***This place covers:*

Actively removing gaseous or liquid materials which are present within discarded articles.

Example US-A-5826631

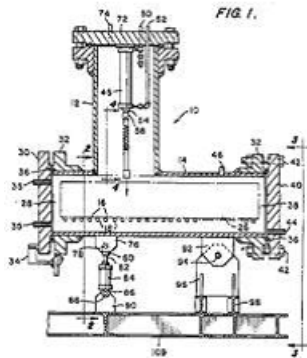

B09B 3/0066

{Disposal of asbestos}

Definition statement

This place covers:

Disposal of asbestos or asbestos-containing waste other than by means of dumping.

Example: WO-A1-99/37590

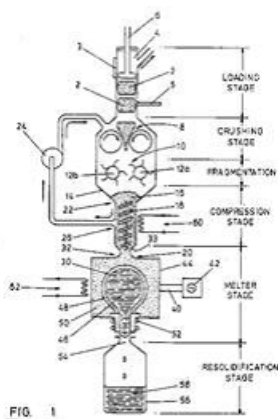

B09B 3/0075

{Disposal of medical waste (casings for used articles, e.g. sharps [A61B 50/362](#); sterilisation of refuse [A61L 11/00](#); disposal of used needles or syringes [A61M 5/3205](#); disintegrating medical waste [B02C 19/0075](#))}

Definition statement

This place covers:

Disposal of medical waste other than by means of dumping.

Example: US-A-5656248

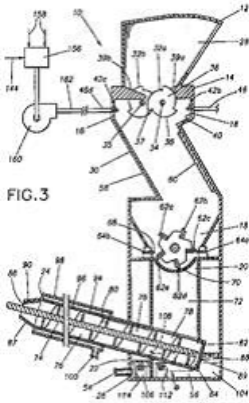

FIG. 3