

B01J

CHEMICAL OR PHYSICAL PROCESSES, e.g. CATALYSIS OR COLLOID CHEMISTRY; THEIR RELEVANT APPARATUS

Definition statement

This place covers:

- Granulation processes or devices, e.g. by dividing liquid material into drops, in drums, in fluidised beds, by expressing the material through sieves, making particulate materials hydrophobic

- Chemical or physical processes or apparatus therefor concerning:

- chemical or physical change of matter by the use of pressure
- feed or outlet regulating devices,
- calcining, fusing,
- apparatus for generating gases
- solidifying liquids
- direct application of electric or wave energy
- production of inert gas mixtures
- stationary, nozzle-type reactors

- Chemical processes involving a gas e.g. gas passing through fixed beds or fluidised beds, reacting liquid with gaseous media other than in presence of solid particles, reacting gaseous media with gaseous media, reacting gaseous media with non-particulate solids.

- Chemical processes involving a liquid e.g. liquids passing through fixed beds or fluidised beds, reacting liquid with gaseous media, reacting liquid with liquids, reacting liquids with non-particulate solids

- Production of colloidal materials or their solutions, e.g. making microcapsules by physical drying, spraying, coacervation, polymerisation,

- Sorbent or filter aid compositions comprising inorganic or organic material, sorbents specially adapted for chromatography and processes for preparing or regenerating thereof

- Catalysts:

- catalysts containing elements or inorganic compounds, e.g. magnesium, silica, copper, noble metals, sulfides, halides, carbides
- Raney catalysts, e.g. Raney nickel
- catalysts comprising molecular sieves, e.g. silicalites, crystalline zeolites, clays, phosphates,
- catalysts comprising metal hydrides, organic compounds, coordination complexes
- catalysts characterised by their form or physical properties
- Preparation processes, protection, activation, e.g. impregnation, coating, reducing
- Regeneration or reactivation of catalysts

Ion exchange processes e.g. cation, anion, amphoteric ion-exchange; regeneration of ion-exchangers and apparatus therefor

Relationships with other classification places

- Polymerization ([C08E](#), [C08G](#)): Apparatus used for polymerization processes should be classified in [B01J](#) since the polymer subclasses usually cover aspects of process and not of the apparatus used.

Reforming / hydrogen production ([C01B](#)): Apparatus used for reforming reactions (production of hydrogen for fuel cell applications) should be classified in [B01J](#) (mainly [B01J 8/00](#) since very often a

catalytic bed is used for catalytic reforming). [C01B](#) covers mainly the process aspects of the reforming and [B01J](#) the aspects relating to the types of apparatus used.

Water treatment ([C02F](#)): if the claims of a patent document classified in [C02F](#) do not specify which kind of fluid is treated, the document should be classified in [B01J 3/00-B01J 12/00](#), [B01J 14/00-B01J 19/00](#), especially regarding apparatus features (UV radiation means, baffles...).

Separation, e.g. distillation, also combined with chemical reaction, is classified in [B01D](#)

Catalysts only used as electrocatalysts are not classified in [B01J](#) but in [H01M](#).

References

Application-oriented references

Examples of places where the subject matter of this place is covered when specially adapted, used for a particular purpose, or incorporated in a larger system:

Separation of liquids by ion-exchange adsorbents	B01J 39/00 - B01J 49/90
Treatment of milk	A23C 9/14
Separation by ion-exchangers	B01D
Chromatography involving ion-exchange	B01D 15/36
Separation of isotopes	B01D 59/00
Compounds per se, see the relevant classes, e.g. Extraction of metal compounds from ores or concentrates by wet processes	C01 , C07 , C08 , C22B 3/00
Compounds per se, see the relevant classes, e.g.	C01 , C07 , C08
Treatment of water	C02F 1/42
Refining of hydrocarbon oils, in the absence of hydrogen, with solid sorbents	C10G 25/00
Purification of sugar juices	C13B 20/14
Extraction of sugar from molasses	C13B 35/06
Extraction of metal compounds from ores or concentrates by wet processes	C22B 3/00
Combustion apparatus in which combustion takes place in a fluidised bed of fuel or other particles	F23C 10/00
Drying solid materials to form a fluidised bed	F26B 3/08
Using ion-exchange for investigating or analysing materials	G01N 30/96
Treating radioactively contaminated material	G21F 9/12

Informative references

Attention is drawn to the following places, which may be of interest for search:

Combinatorial chemistry / array manufacture	B01J 19/0046 , C40B
Catalyst and sorbent compositions	B01J 20/00- B01J 38/00
Sterilization, disinfection, deodorization	A61K , A61L
Preparations for medical purposes (e. g. radioelements)	A61K
Treating hazardous wastes	A62D
Distillation	B01D 3/00
Crystallization processes in general	B01D 9/00

Filtration	B01D 39/00
Absorption processes	B01D 53/00
Exhaust gas treating	B01D 53/86 , B01D 53/94 - B01D 53/9495
Membranes per se	B01D 63/00
Mixing	B01F 3/00 - B01F 15/00
Laboratory equipment	B01L
Lab-on-a-chip	B01L 3/00
Cyclones per se	B04C
Ultrasonic devices per se	B06B 3/00
Cleaning reactors	B08B
Waste incineration	B09B
Treating soils	B09C 1/00
Control when application is electrically driven vehicles	B60L
Storage containers, bags	B65B
Making microstructures	B81B
Hydrogen production	C01B 3/00
Process for preparing hydrogen using catalysts	C01B 3/38
Carbon / nanocarbon	C01B 32/00
Ammonia production	C01C 1/00
Water treatment	C02F
General methods of organic chemistry	C07B
Process for preparing acyclic or carbocyclic compounds	C07C
Preparation of hydrocarbons, such as ethylene and propylene, from one or more compounds, none of them being a hydrocarbon, starting from organic compounds containing only oxygen atoms as heteroatoms, such as methanol	C07C 1/20
Preparation of compounds having hydroxy or O-metal groups bound to a carbon atom not belonging to a six-membered aromatic ring by reduction of an oxygen containing functional group	C07C 29/132
Preparation of compounds having hydroxy or O-metal groups bound to a carbon atom not belonging to a six-membered aromatic ring, such as ethanol by reduction of oxides of carbon exclusively characterised by the catalyst used	C07C 29/153
Preparation of compounds having >C = O groups bound only to carbon or hydrogen atoms, such as (meth)acrolein, by oxidation of unsaturated hydrocarbons	C07C 45/35
Preparation of carboxylic acids or their salts, halides or anhydrides, such as acrylic acid, by oxidation of saturated or unsaturated hydrocarbons	C07C 51/252+ C07C 57/04 , C07C 51/215+ C07C 57/04
Preparation of carboxylic acid esters, e.g. vinyl acetate, by reacting carboxylic acids or symmetrical anhydrides onto unsaturated carbon-to-carbon bonds with oxidation	C07C 67/05 , C07C 67/055

Preparation of carboxylic acid nitriles by ammoxidation of hydrocarbons or substituted hydrocarbons	C07C 253/24
Process for preparing heterocyclic compounds	C07D
Preparation of oxiranes, such as ethylene oxide or propylene oxide, by oxidation	C07D 301/00
Polymerization	C08F , C08G
Coke oven, pyrolysis	C10B
Fluid catalytic cracking (FCC), Fischer-Tropsch process	C10G
Production of liquid hydrocarbon mixtures from carbon monoxide with hydrogen with the use of catalysts	C10G 2/30
Catalytic cracking of hydrocarbon oils	C10G 11/00
Catalytic reforming naphtha	C10G 35/04
Hydrotreating, such as hydrodesulphurising, hydroisomerising and hydrogenating, hydrocarbon oils	C10G 45/00
Hydrocracking hydrocarbon oils	C10G 47/00
Hydroprocessing hydrocarbon oils	C10G 49/00
Gasification	C10J
Bioreactors	C12M
Chemical vapor deposition processes	C23C 16/00
Electrolytic processes	C25B , C25C
Single crystal growth	C30B
Exhaust gas treatment for NOx	F01N 3/00
Pumps	F04B 13/00
Valves	F16J
High pressure vessels in generalPresses	F16J 13/00 , B30B
Combustion of solid and fluent fuelsInternal combustion engines	F23 , F02M 27/02
Cleaning air, conditioners	F24F 3/00
Drying solids	F26B
Heat exchange	F28D 9/00 , F28F 3/00
Analysis	G01N
Control for other applications	G05B 13/00
Surface treatment of semi-conductors	H01L 21/00
Fuel cells / batteries similar signals	H01M 6/00 , H01M 8/00
Microwave devices, UV devices	H05B 6/80
Electrostatic charges (removing of)	H05F 3/04
Plasma reactors per se	H05H 1/00

Special rules of classification

- The most important aspect of [B01J 3/00-B01J 12/00](#), [B01J 14/00-B01J 19/00](#)(except [B01J 19/0046](#)) is the fact, that it covers general chemical and/or physical processes or apparatus, used in chemistry and / or physico-chemistry, mainly on industrial scale (except microreactors [B01J 19/0093](#)). It focuses on the devices, thus reactors (technical characteristics thereof, as well as equipment in cooperation

therewith). In this context, devices for specific applications are normally (unless some agreements are provided between technical fields) to be classified in these more specific application fields, especially where these fields foresee classes for devices (for example devices for combustion, pyrolysis, gasification, manufacturing of semi-conductors etc.) and not in [B01J 3/00-B01J 19/00](#). Consequently processes or apparatus for specific applications should be at a first stage classified in the relevant specific classes for these processes or apparatus. If specific aspects of these processes or apparatus could be generalized and could then be of interest for search purposes, [B01J](#) classes can also be used at a second stage for classification of these processes or apparatus.

Thus specific technical fields should not be mixed with [B01J](#), unless agreements exist between fields (e.g.: hydrogen production).

- Whole documents should be classified, not only the claims of a patent, but also the content of the description and of the drawings.

Indexing Code ([B01J 2203/00](#), [B01J 2208/00](#) and [B01J 2219/00](#)) are used to classify additional information not covered by the classes. In some cases Indexing Codes are mainly used as subdivision of a specific class (for example the microreactors or the plate type reactors), whereas in other cases the Indexing Codes are used for a whole group of classes (typical example are the Indexing Code relating to heat exchange aspects).

- A material is classified as catalyst when

- the application states that it is useful as catalyst (or catalyst support), and
- when details regarding its composition, properties, preparation or regeneration are disclosed.

- Aspects of the catalyst to be classified:

- Composition of the catalyst ([B01J 21/00](#), [B01J 23/00](#), [B01J 25/00](#), [B01J 27/00](#), [B01J 29/00](#))
- [B01J 32/00](#) for such carriers is not used, but covered by appropriate groups of [B01J 21/00](#) - [B01J 29/00](#);
- if applicable: protection of catalysts ([B01J 33/00](#))
- Physical-chemical properties of the catalyst ([B01J 35/00](#))
- Preparation of the catalyst ([B01J 37/00](#))
- Regeneration of the catalyst ([B01J 38/00](#); [B01J 21/20](#), sub-groups of [B01J 23/90](#), [B01J 25/04](#), sub-groups of [B01J 27/28](#), [B01J 29/90](#))

Exceptions: Catalysts only used as electrocatalysts are not classified in [B01J](#) but in [H01M](#).

- Catalysts comprising organic compounds, metal hydrides, organometallic compounds, and coordination complexes are classified in [B01J 31/00](#).

- Pure compounds or elements, are classified in the appropriate subclass for chemical compounds or elements.

Molecular sieves per se are classified in [C01B](#)

However, when it is explicitly stated or claimed that the pure compound, element, zeolite etc, in a particular form, is especially useful as a catalyst, it is additionally classified in group [B01J 21/00-B01J 29/90](#) or [B01J 32/00-B01J 35/00](#).

- Multiple classification:

In addition to classifying in [B01J](#), the uses of the catalysts are further classified in the appropriate classes of [B01D](#), [C01B](#), [C01C](#), [C07B](#), [C07C](#), [C07D](#), [C10G](#), [C11B](#) and [C11C](#).

- Which parts of the application / patent to classify for catalysts

Each specifically disclosed embodiment, in particular each example, giving details regarding composition, properties, preparation or regeneration of the catalyst (or catalyst support) is classified, even if the application / patent does not claim a catalyst per se. In case of claims relating to a catalyst,

if classification of the examples only does not suitably reflect the subject-matter of the claims, additional, general classes are given to cover the scope of the catalyst claims.

Reformed ECLA approach

In these groups new documents are classified according to the reformed ECLA approach, i.e. important (invention-related) information is identified with ECLA classification symbols, e.g. [B01J 23/02](#), other (secondary) information with Indexing Code symbols, e.g. [B01J 23/02](#).

"Last place rule"

In each set of groups [B01J 21/00](#) - [B01J 33/00](#), in the absence of an indication to the contrary, classification is made in the last appropriate place ("last place rule").

How to use the "last place rule" for classifying the composition of the catalyst

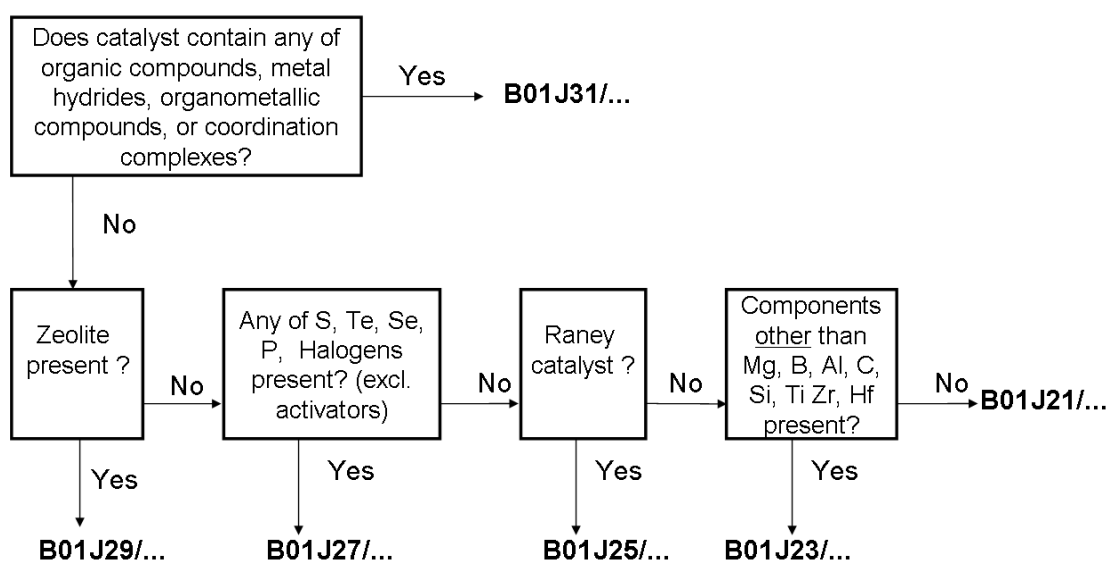

The preceding image includes references to [B01J 31/00](#), [B01J 29/00](#), [B01J 27/00](#), [B01J 25/00](#), [B01J 23/00](#).

Last place rule within B01J23/...

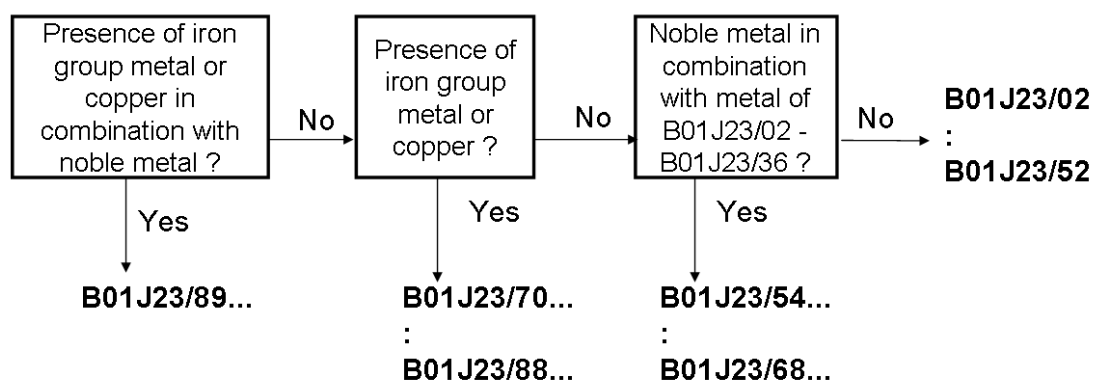

The preceding image includes references to [B01J 23/02](#), [B01J 23/52](#), [B01J 23/89](#), [B01J 23/70](#), [B01J 23/88](#), [B01J 23/54](#), [B01J 23/68](#).

Example: MoVSbOx

Antimony [B01J 23/18](#)

Vanadium [B01J 23/22](#)

Molybdenum [B01J 23/28](#)

==> classified in the last place, namely [B01J 23/28](#)

Example: MoVSbFeOx

Iron [B01J 23/745](#)

Iron combined with Vanadium [B01J 23/8472](#)

Iron combined with Antimony [B01J 23/8435](#)

Iron combined with Molybdenum [B01J 23/881](#)

Iron combined with Molybdenum, further containing Antimony [B01J 23/8876](#)

Iron combined with Molybdenum, further containing Vanadium [B01J 23/8877](#)

==> classified in the last place, namely [B01J 23/8877](#)

Multiple classification: How to classify mixed oxides, spinels and mixed salts (e.g. hydrotalcite)

In addition to the appropriate class according to the "last place rule", mixed oxides are classified in [B01J 23/002](#), spinels are classified in [B01J 23/005](#) or [B01J 21/005](#), and mixed salts (e.g. hydrotalcite) are classified in [B01J 23/007](#).

In addition, mixed oxides (including spinels etc) containing 3 or more elements other than oxygen, are indexed using a combination class based on [B01J 23/002](#) (see comments on [B01J 23/002](#)). This only applies to the specific mixed oxides of the working examples.

How to classify catalysts composed of separately prepared, distinguishable parts having different compositions

Such catalysts are classified in [B01J 35/0006](#). The appropriate class for the catalyst composition as a whole is given. In addition, each part is classified as a separate catalyst. Exception: Mixtures of molecular sieves are classified in [B01J 29/005](#) or [B01J 29/80](#) and receive Indexing Codes chosen from groups [B01J 29/03](#) - [B01J 29/046](#) to identify the individual constituents of these mixtures

Example: Admixture of zeolite ZSM-5 and Pt/Al₂O₃

[B01J 35/0006](#), [B01J 29/44](#), [B01J 29/40](#), [B01J 23/42](#)

Example: Zeolite ZSM-5 shaped with Al₂O₃ as matrix, and then impregnated with Pt [B01J 29/44](#); also assign [B01J 2229/20](#)

Example: Zeolite ZSM-5 mixed with Pt-impregnated Zeolite Y.

[B01J 29/80](#), [B01J 29/40](#), [B01J 29/126](#); also assign [B01J 2229/18](#)

How to classify supported catalysts

The carrier is normally not classified, unless the inventive idea is linked to the nature of the support. In this case, the support per se is also classified, usually in [B01J 21/00](#) If appropriate, an Indexing Code is given (additional information).

Metal catalysts or metal oxide catalysts activated or conditioned by halogens, sulfur or phosphorus, or compounds thereof are classified in the appropriate groups for metal or metal oxide catalysts ([B01J 23/00](#)) and in the groups relevant for activation / conditioning ([B01J 37/00](#))

Heteropolyacids are classified in [B01J 27/188](#) and subgroups

If metals are introduced into the framework of the molecular sieve already in the synthesis stage, [B01J 29/86](#) - [B01J 29/89](#) and [B01J 29/046](#) - [B01J 29/048](#) take precedence.

The use of catalysts must also be classified in the appropriate groups, such as in [C01B](#), [C01C](#), [C10G](#), [C07B](#), [C07C](#), [C07D](#)

Glossary of terms

In this place, the following terms or expressions are used with the meaning indicated:

Catalyst	covers also a carrier forming part of the catalyst
Zeolites	- crystalline aluminosilicates with base-exchange and molecular sieve properties, having three dimensional, microporous lattice framework structure of tetrahedral oxide units;- compounds isomorphous to those of the former category, wherein the aluminium or silicon atoms in the framework are partly or wholly replaced by atoms of other elements, e.g. by gallium, germanium, phosphorus or boron.

Synonyms and Keywords

In patent documents, the following words/expressions are often used as synonyms:

- "Raney catalyst", "sponge-metal catalyst" and "skeletal catalyst"

B01J 2/00

**Processes or devices for granulating materials {, e.g. fertilisers} in general;
Rendering particulate materials free flowing in general, e.g. making them hydrophobic**

Definition statement

This place covers:

Processes or devices for granulation/agglomeration, which are applicable to (more than one) different fields of application, such as food, cosmetics, pharmaceuticals, fertilisers or for which no specific application is indicated.

Relationships with other classification places

Processes for granulating fertilisers characterised by their chemical constitution: [C05B](#) - [C05G](#)

References

Application-oriented references

Examples of places where the subject matter of this place is covered when specially adapted, used for a particular purpose, or incorporated in a larger system:

Granulating metals	B22F 9/00
Making granules from plastics or from substances in a plastic state	B29B 9/00
Processes for granulating fertilisers characterised by their chemical composition	C05B-C05G
Chemical aspects of granulating macromolecular substances	C08J 3/12
Granulating slag	C21B 3/06
Granulating ores or scrap	C22B 1/14

Informative references

Attention is drawn to the following places, which may be of interest for search:

Processes for preparing catalysts by granulating	B01J 37/0063
Agglomerating or granulating milk powder	A23C 9/16
Preparing unshaped finely divided cereal products, e.g. flour	A23L 7/198
Devices or methods adapted for bringing pharmaceutical products into a particular form	A61J 3/00
Medical preparations in particulate form	A61K 9/14
Medical preparations in form of granules or agglomerates	A61K 9/16
Medical preparations obtained by tableting processes	A61K 9/2095
Crushing, pulverising or disintegrating solids	B02B
Granulating metals	B22F 9/00
Working of plastics or substances in a plastic state to make granules	B29B 9/00
Granulation of ammonium nitrate fertilisers	C05C 1/02
Granulation of nitrogenous fertilisers containing calcium or other cyanamides	C05C 7/02
Post-treatment of fertilisers containing urea or urea compounds	C05C 9/005
Granulation of fertiliser compounds	C05G 3/0058
Chemical aspects of powdering or granulating of macromolecular substances	C08J 3/12
Granulating slag	C21B 3/06
Granulating ores or scrap	C22B 1/14
Production of ice	F25C 1/00

Special rules of classification

Concepts teaching general principals of granulation / agglomeration which can be applied in different fields of application, e.g. food, pharmaceuticals, fertilisers, are classified in [B01J 2/00](#).

If a specific granulation concept is mentioned in a document without further details, an Indexing Code chosen from [B01J 2/00](#) may be allocated.

Microencapsulation is classified in [B01J 13/00](#)

B01J 2/003

{followed by coating of the granules (to prevent the granules sticking together [B01J 2/30](#))}

Relationships with other classification places

Processes and apparatus for applying liquids on surfaces: [B05C](#), [B05D](#)

References**Limiting references**

This place does not cover:

Preventing granules sticking together	B01J 2/30
---------------------------------------	---------------------------

Informative references

Attention is drawn to the following places, which may be of interest for search:

Processes for preparing solid sorbent compositions by impregnating or coating	B01J 20/32
Processes for preparing catalysts by impregnation of coating	B01J 37/02
Processes and devices for covering fertilisers	C05G 3/0005

B01J 2/006

{Coating of the granules without description of the process or the device by which the granules are obtained (to prevent the granules sticking together [B01J 2/30](#))}

Relationships with other classification places

Processes and apparatus for applying liquids on surfaces: [B05C](#), [B05D](#)

References**Limiting references**

This place does not cover:

Preventing granules sticking together	B01J 2/30
Making microcapsules	B01J 13/00

Informative references

Attention is drawn to the following places, which may be of interest for search:

Processes for preparing solid sorbent compositions by impregnating or coating	B01J 20/32
Processes for preparing catalysts by impregnation of coating	B01J 37/02
Processes and devices for covering fertilisers	C05G 3/0005

B01J 2/02

by dividing the liquid material into drops, e.g. by spraying, and solidifying the drops

Relationships with other classification places

Spraying or apparatus, nozzles: [B05B](#)

References**Informative references**

Attention is drawn to the following places, which may be of interest for search:

Nozzle type reactors	B01J 19/26
Processes for preparing catalysts by drying a slurry, e.g. spray drying	B01J 37/0045
Evaporating by spraying	B01D 1/16

Evaporation by spraying to obtain dry solids	B01D 1/18
Drying solid materials by convection in the form of a spray	F26B 3/12

B01J 2/04

in a gaseous medium {(if combined with suspending the material in a gas, e.g. fluidised beds [B01J 2/16](#))}

Relationships with other classification places

Spraying or apparatus, nozzles: [B05B](#)

References

Limiting references

This place does not cover:

If combined with suspending the material in a gas, e.g. fluidised beds	B01J 2/16
--	---------------------------

Informative references

Attention is drawn to the following places, which may be of interest for search:

Nozzle type reactors	B01J 19/26
Processes for preparing catalysts by drying a slurry, e.g. spray drying	B01J 37/0045
Evaporation by spraying to obtain dry solids	B01D 1/18
Drying solid materials by convection in the form of a spray	F26B 3/12

B01J 2/10

in stationary drums or troughs, provided with kneading or mixing appliances

References

Informative references

Attention is drawn to the following places, which may be of interest for search:

Stationary reactors having moving elements inside	B01J 19/18
---	----------------------------

B01J 2/12

in rotating drums

References

Informative references

Attention is drawn to the following places, which may be of interest for search:

Moving reactors, e.g. rotary drums	B01J 19/28
------------------------------------	----------------------------

B01J 2/16

by suspending the powder material in a gas, e.g. in fluidised beds or as a falling curtain

References**Informative references**

Attention is drawn to the following places, which may be of interest for search:

Chemical or physical processes with fluidised particles	B01J 8/18
---	---------------------------

B01J 2/18

using a vibrating apparatus

References**Informative references**

Attention is drawn to the following places, which may be of interest for search:

Application of shock-waves for chemical reactions or for modifying the crystal structure of substances	B01J 3/08
General processes employing sonic or ultrasonic vibrations	B01J 19/10

Special rules of classification

Processes for granulating materials in general using a pressure or shock waves will be classified in [B01J 2/18](#), [B01J9/10](#) and [B01J 3/08](#)

B01J 2/20

by expressing the material, e.g. through sieves and fragmenting the extruded length

References**Informative references**

Attention is drawn to the following places, which may be of interest for search:

Preparation of plastics by extrusion	B29B 9/06
--------------------------------------	---------------------------

B01J 2/22

by pressing in moulds or between rollers

References**Informative references**

Attention is drawn to the following places, which may be of interest for search:

Preparation of plastics by moulding	B29B 9/10
-------------------------------------	---------------------------

B01J 2/24**Obtaining flakes by scraping a solid layer from a surface****References****Informative references**

Attention is drawn to the following places, which may be of interest for search:

Preparation of plastics by dividing preformed material	B29B 9/02
--	---------------------------

B01J 2/26**on endless conveyor belts****References****Informative references**

Attention is drawn to the following places, which may be of interest for search:

Stationary reactors having moving elements inside in the form of endless belts	B01J 19/22
--	----------------------------

B01J 3/00

Processes of utilising sub-atmospheric or super-atmospheric pressure to effect chemical or physical change of matter; Apparatus therefor (pressure vessels for containing or storing compressed, liquefied or solidified gases [F17C](#))

References**Limiting references**

This place does not cover:

Pressure vessels for containing or storing compressed, liquefied or solidified gases	F17C
--	----------------------

Application-oriented references

Examples of places where the subject matter of this place is covered when specially adapted, used for a particular purpose, or incorporated in a larger system:

Apparatus for compacting or sintering of metal powders	B22F 3/00
Pressure vessels for nuclear reactors	G21C

Informative references

Attention is drawn to the following places, which may be of interest for search:

Pressure vessels or autoclaves for sterilization	A61K
Pressure vessels or autoclaves for laboratory purposes	B01L
Coating metallic material	C23C

Making single crystals	C30B
Pressure vessels in general	F16J 12/00

Special rules of classification

[B01J 3/062](#): Indexing Code [B01J 2203/0605](#), [B01J 2203/065](#) and [B01J 2203/0675](#) are used as a subdivision of this sub-group.

B01J 3/06

Processes using ultra-high pressure, e.g. for the formation of diamonds;
Apparatus therefor, e.g. moulds or dies ([B01J 3/04](#) takes precedence)

References

Informative references

Attention is drawn to the following places, which may be of interest for search:

Presses in general	B30B
--------------------	----------------------

B01J 3/08

Application of shock waves for chemical reactions or for modifying the crystal structure of substances

References

Informative references

Attention is drawn to the following places, which may be of interest for search:

Blasting	F42D
----------	----------------------

B01J 4/00

Feed {or outlet} devices; Feed or outlet control devices (feed or outlet devices for pressure vessels [B01J 3/02](#) {; feeding of particles into and evacuation of particles out of the reactor [B01J 8/0015](#)})

Definition statement

This place covers:

Apparatus moving the material into or out the chemically or physically processor

References

Limiting references

This place does not cover:

Feed or outlet devices for pressure vessels	B01J 3/02
Feeding of particles into and evacuation of particles out of the reactor	B01J 8/0015

Special rules of classification

This group covers the feeding devices of the reactors which are classified in [B01J 19/00](#). A feeding device for feeding reactive fluids in a reactor classified in [B01J 8/00](#) should not be classified in [B01J 4/00](#) but only in [B01J 8/00](#).

If the feeding device comprises a nozzle element, it should be classified in [B01J 4/002](#). [B01J 19/26](#) should be used if the reaction takes place in the nozzle device (the nozzle device is not only used for feeding purposes but also for reacting purposes).

B01J 6/00

{Heat treatments such as} Calcining; Fusing {Pyrolysis (furnaces [F27D](#))}

Definition statement

This place covers:

Thermal treatment processes in the presence of air, fired in a kiln, or thermochemical decomposition at elevated temperatures in the absence of oxygen

References

Limiting references

This place does not cover:

Pyrolysis	C10B 53/00 , C10J 3/00 , C10G 1/00
Furnaces	F27D

B01J 7/00

Apparatus for generating gases (production of inert gas mixtures [B01J 19/14](#); for generating specific gases, see the relevant subclasses, e.g. [C01B](#), [C10J](#) {; in "air bags" on vehicles [B60R 21/26](#); for starter gas [F02C 7/26](#); blasting cartridges for producing gas under pressure [F42B 3/04](#)})

References

Limiting references

This place does not cover:

Feeding of particles into and evacuation of particles out of the reactor	B01J 8/0015
Production of inert gas mixtures	B01J 19/14
For generating gases in air bags on vehicles	B60R 21/26
For generating specific gases, see the relevant subclasses	C01B , C10J
For starter gas	F02C 7/26
Blasting cartridges for producing gas under pressure	F42B 3/04

B01J 8/00

Chemical or physical processes in general, conducted in the presence of fluids and solid particles; Apparatus for such processes

Definition statement

This place covers:

The condition for classifying a document in [B01J 8/00](#) is that solid particles, especially catalytic particles, should be always present, at the beginning of the reaction. If a process leads to the formation of some solid particles (e. g. polymerization process), and no solid particles were present at the beginning of the process, the document should not be classified in [B01J 8/00](#). Furthermore the feature "solid particles" does not apply only to small (catalytic or non-catalytic) particles, but also to random packing elements (e. g. Raschig rings). Random packings as such should be classified in [B01J 19/30](#) and additionally in [B01J 8/00](#) if an apparatus which contains these random packings is disclosed.

For the specific case of a plate-type reactor with catalytic particles between the plates, [B01J 19/249](#) and the Indexing Code-code [B01J 2219/2481](#) take preference.

For the specific case of a monolithic reactor with catalytic particles in the monolithic channels, [B01J 19/2485](#) and the Indexing Code-code [B01J 2219/243](#) take preference.

If a catalyst is present but not in granular form, appropriate classes are [B01J 10/007](#), [B01J 12/007](#), [B01J 14/005](#), [B01J 15/005](#), [B01J 16/005](#).

References

Application-oriented references

Examples of places where the subject matter of this place is covered when specially adapted, used for a particular purpose, or incorporated in a larger system:

Furnaces conducted in the presence of fluids and solid particles	F27B
--	----------------------

Informative references

Attention is drawn to the following places, which may be of interest for search:

Processes or devices for granulating material	B01J 2/00
Absorption	B01J 13/00
Adsorption	B01D
Loading and unloading vessels in general	B65G
Heat exchange apparatus	F28C 3/10 , F28D 13/00 , F28D 17/00 , F28D 19/00

Special rules of classification

For classification in [B01J 8/00](#), a large group of Indexing Code-codes [B01J 2208/00](#) has been created; these Indexing Code-codes are very important for search purposes and should be used extensively for classifying additional information.

[B01J 8/002](#): a moving instrument is used for feeding or evacuating the solid particles; in [B01J 8/0045](#) a rotary device is located in the flow channel used for introducing or evacuating the solid particles.

Moving can be also a rotary movement. If there is also a flow channel, then it's classified in [B01J 8/002](#).

Example for [B01J 8/002](#): reference 6 (rotating blades) Example for [B01J 8/0045](#):

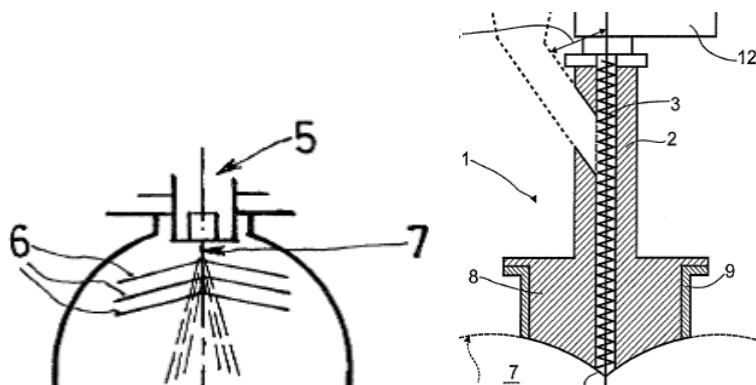

[B01J 8/0292](#): this subgroup should be used if some stationary packing material is embedded in a bed of some other solid particles (mixture of packing elements and other solid particles).

[B01J 8/18](#): in this subgroup "fluidized particles" means that the particles are completely fluidized and a bed is not visible; each particle can move upwardly and downwardly independently from the movement of the other particles. It means that the speed of the fluidizing gas is higher than in case of a fluidized bed.

[B01J 8/1854](#): for a polymerization process carried out in a tubular loop-type reactor, [B01J 19/1837](#) or [B01J 19/2435](#) should be used instead of [B01J 8/1854](#) if no solid particles are present at the beginning of the reaction.

[B01J 8/24](#): in this subgroup "fluidized bed" means that the particles are fluidized but a compact bed is still visible. The speed of the fluidized gas is lower than in the case of fluidized particles.

B01J 8/14

moving in free vortex flow apparatus

References

Informative references

Attention is drawn to the following places, which may be of interest for search:

Free vortex flow apparatus	B04C
----------------------------	----------------------

B01J 8/24

according to "fluidised-bed" technique ([B01J 8/20](#) takes precedence)

References

Application-oriented references

Examples of places where the subject matter of this place is covered when specially adapted, used for a particular purpose, or incorporated in a larger system:

Combustion apparatus in which combustion takes place in a fluidised bed	F23C 10/00
---	----------------------------

B01J 10/00

Chemical processes in general for reacting liquid with gaseous media other than in the presence of solid particles, or apparatus specially adapted therefor ([B01J 19/08](#) takes precedence; separation, e.g. distillation, also combined with chemical reactions [B01D](#), {e.g. [B01D 3/009](#)})

Definition statement

This place covers:

Chemical processes in general for reacting liquid with gaseous media other than in the presence of solid particles, or apparatus specially adapted therefore ([B01J 19/08](#) takes precedence).

References

Limiting references

This place does not cover:

Separation, e.g. distillation, evaporation	B01D
--	----------------------

Special rules of classification

[B01J 10/00](#) Subgroups should be used for classification of process features. Apparatus features should be classified in the [B01J 19/00](#) Subgroups.

[B01J 10/02](#): for apparatus aspects, see [B01J 19/1887](#) or [B01J 19/247](#).

For the specific case of a plate-type reactor with plates coated with a catalytic porous coating, [B01J 19/249](#) and the Indexing Code-codes under [B01J 2219/245](#) take preference.

Microchannels reactors are classified in [B01J 19/0093](#)

B01J 12/00

Chemical processes in general for reacting gaseous media with gaseous media; Apparatus specially adapted therefor ([B01J 3/08](#), [B01J 8/00](#), [B01J 19/08](#) take precedence)

Special rules of classification

If an apparatus is disclosed in detail, the corresponding apparatus features should also be classified in the [B01J 19/00](#) Subgroups.

For the specific case of a plate-type reactor with plates coated with a catalytic porous coating, [B01J 19/249](#) and the Indexing Code-codes under [B01J 2219/245](#) take preference.

Gas-gas reactions conducted in the presence of solid particles are classified in [B01J 8/00](#):

B01J 13/00

Colloid chemistry, e.g. the production of colloidal materials or their solutions, not otherwise provided for; Making microcapsules or microballoons

Definition statement

This place covers:

Methods for producing colloidal materials or their solutions, e.g. sols, gels, aerosols, aerogels as well as methods for producing microcapsules or microballoons.

Relationships with other classification places

Sols containing an elemental metal for medical purposes are classified in [A61K](#).

Sols containing an elemental method for diagnostical purposes are classified in [G01N](#).

Colloid mills are classified in [B02C](#).

References

Application-oriented references

Examples of places where the subject matter of this place is covered when specially adapted, used for a particular purpose, or incorporated in a larger system:

Use of substances as emulsifying, wetting, dispersing or foam-producing agents	B01F 17/00
--	----------------------------

Informative references

Attention is drawn to the following places, which may be of interest for search:

Preventing evaporation or oxidation of non-metallic liquids by applying a floating layer comprising microcapsules	B01J 19/16
Microcapsules comprising biocide, pest repellent, pest attractant, plant growth regulator	A01N 25/28
Microcapsules comprising feed	A23K 40/30
Microcapsules comprising flavouring agent	A23L 27/72
Microcapsules comprising foodstuff, foodstuff additives	A23P 10/30
Absorbent pads, e.g. towels, swabs, tampons comprising microcapsules comprising perfume or medicaments	A61F 2013/8452
Nanocapsules comprising cosmetic or similar toilet preparations	A61K 8/11
Tablets comprising microcapsules comprising drugs	A61K 9/2081
Microcapsules or microballoons for medical preparations	A61K 9/50
Mixture of drugs of which at least one is microencapsulated	A61K 9/5084
Microcapsules comprising magnetic carrier material, e.g. ferrite for drug targeting	A61K 9/5094
Nanocapsules comprising medicinal preparations	A61K 9/51
Microcapsules comprising living eukaryotic cells	A61K 2035/128
Microcapsules or nanocapsules comprising a medicinal preparation chemically bound to a non-active ingredient, e.g. polymer-drug conjugate	A61K 47/6925
Microcapsules comprising X-ray contrast reagents	A61K 49/0419

Nanocapsules comprising X-ray contrast reagents	A61K 49/0423
Microcapsules comprising halogenated organic X-ray contrast reagents	A61K 49/048
Nanocapsules comprising halogenated organic X-ray contrast reagents	A61K 49/0485
Microparticles comprising NMR contrast preparation	A61K 49/1818
Microcapsules comprising gas as echographic or ultrasound imaging preparation	A61K 49/223
Microcapsules comprising radioactive substance for therapeutic use or testing in vivo	A61K 51/1265
Inhalator comprising microcapsules	A61M 15/0011
Microcapsules comprising fire-extinguishing compositions	A62D 1/0021
Breaking microcapsules to make a message legible in lotto or bingo board games	A63F 3/0685
Tickets of lotto or bingo board games, raffle games having a message become legible by breaking microcapsules	A63F 3/0685
Moulding polymers or prepolymers comprising microcapsules comprising ingredients	B29C 67/247
Shaped material comprising microcapsules	B29K 2105/0076
Material comprising microballoon fillers	B29K 2105/165
Layered particles essentially comprising metal	B32B 15/02
Filled microcapsules	B32B 2305/54
Using pressure to make a masked colour visible characterised by the use of microcapsules	B41M 5/165
Thermography using microcapsules	B41M 5/287
Contact thermal transfer or sublimation process using microcapsules	B41M 5/38271
Colloidal silica	C01B 33/14
Use of inorganic microballoons as fillers for mortars, concrete or artificial stone	C04B 14/02
Use of microballoons as fillers for mortars, concrete or artificial stone	C04B 20/0016
Use of porous ceramic microballoons in porous mortar, concrete, artificial stone or ceramic ware	C04B 38/009
Microcapsules comprising accelerator in order to inhibit setting of mortar, concrete, artificial stone by mechanical separation of ingredients	C04B 40/0641
Working up of compositions comprising microballoons and macromolecular substance to porous or cellular materials	C08J 9/32
Microcapsules comprising dye, dyes	C09B 67/0097
Materials not provided elsewhere for aerosols	C09K 3/30
Microcapsules comprising lubricant	C10N 2250/16
Microcapsules comprising perfume	C11D 3/505
Microcapsules comprising detergent	C11D 17/0039
microcapsules comprising a treating agent for the treatment of fibres, threads, yarns, fabrics, fibrous goods	D06M 23/12
Microcapsules added to pulp	D21H 21/54
microcapsules comprising latent heat storage material	F28D 20/023

Microcapsules as distributed sensing elements for measuring force or stress	G01L 1/247
Liposomes or microcapsules for investigating or analysing materials, immunoassay	G01N 33/5432
Labelled liposomes or microcapsules for investigating or analysing materials	G01N 33/586
Microcapsules copiers	G03B 2227/325
Photosensitive materials comprising microcapsules	G03C 1/002
Structures with microcapsules in the context of photosensitive materials for diffusion transfer processes	G03C 8/426
Photomechanical, e.g. photolithographic, production of textured or patterned surfaces, e.g; printing surfaces, using microcapsules	G03F 7/002
Labels, tag tickets comprising microcapsules	G09F 2003/028

Special rules of classification

The following areas are not included in this group:

- Colloid materials or solutions, microcapsules, microballoons, or other particles per se, without clear indication of the method of preparation.
- Suspensions, dispersions, emulsions that are not colloidal and methods for producing them.
- Methods for producing particles other than those mentioned in the title of the subclass, e.g. matrix-type microparticles.

Methods for producing microcapsules by physical processes where the inventive aspect resides in the apparatus are classified in [B01J 13/04](#) or hierarchically lower groups. Other methods for producing microcapsules by non-chemical processes are classified in [B01J 13/02](#) or hierarchically lower groups.

Glossary of terms

In this place, the following terms or expressions are used with the meaning indicated:

Colloid	a substance microscopically dispersed evenly throughout another substance. The colloidal system, which may be solid, liquid or gaseous, has a very high stability, i.e. precipitation does not occur under the influence of gravity.
Microcapsule	a core-shell particle with a stable, non-transient shell
Microballoon	a gas-filled microcapsule
Sol	a colloidal system of solid particles in a liquid medium
Non-Newtonian sol	sol displaying a decreasing viscosity with increasing shear stress
Gel	a substantially dilute cross-linked system, which exhibits no flow when in the steady-state. A gel has the appearance of a jelly-like material.
Aerosol	a colloidal system comprising fine solid particles or liquid droplets in a gaseous medium
Aerogel	a gel in which the liquid component of the gel has been replaced with a gas
Xerogel	a solid formed from a gel by drying with unhindered shrinkage
Simple coacervation	phase separation process involving only one type of hydrophilic polymer

Complex coacervation	phase separation process involving at least two types of hydrophilic polymers
Interfacial polymerization	polymerization process where the reactants (monomers) meet at an interface where the polymerization reaction occurs and the shell material if formed
In situ polymerization	polymerization process where all reactants (monomers) are present in the same phase. Also processes comprising an initiator in the other phase are in situ polymerization processes.
After-treatment of capsule walls by coating	process in which coating of the microcapsule wall results in core-multiple shell particles
Dispersant	A non-surface active polymer or a surface active substance added to a suspension to improve the separation of particles and to prevent settling or clumping
Emulsion	Two immiscible liquids mixed with small droplets of one liquid dispersed (separated and distributed throughout the space) in the other liquid
Foam	Substance that is formed from trapped gas bubbles
Fog	Collection of liquid water droplets or ice crystals suspended in the air
Surface active agents(surfactants)	Substance which have the effect of reducing the surface tension of a solvent. These substances also known as wetting agents, contain a combination of polar (hydrophilic) and non-polar (hydrophobic) parts which serve to bind oil and water together. They locate at the phase boundary between the water phase and the organic phase, or if there is no room there, they will congregate together and form micelles.
HLB	Hydrophilic-lipophilic balance of a surfactant. Measure of the degree to which it is hydrophilic or lipophilic.
Organosol	Finely divided or colloidal suspension of insoluble material in a suspending organic liquid
Thixotropic fluid	Fluid which takes a finite time to attain equilibrium viscosity when introduced to a step change in shear rate
O/W emulsion	Oil-in- water emulsion
W/O emulsion	Water-in-oil emulsion
W/O/W emulsions	Water-in-oil-in-water multiphase emulsions

Synonyms and Keywords

In patent documents, the following words/expressions are often used as synonyms:

- "microcapsule", "microballoon", "microsphere", "nanocapsule", "nanoballoon", "nanosphere", "core-shell particle", "microencapsulated agent" and "nanoencapsulated agent"

B01J 14/00

Chemical processes in general for reacting liquids with liquids; Apparatus specially adapted therefor ([B01J 8/00](#), [B01J 19/08](#) take precedence)

Definition statement

This place covers:

Chemical processes and apparatus specially adapted for reacting liquids with liquids other than in the presence of solid particles.

Special rules of classification

Liquid-liquid reactions conducted in the presence of solid particles are classified in [B01J 8/00](#)

B01J 15/00

Chemical processes in general for reacting gaseous media with non-particulate solids, e.g. sheet material; Apparatus specially adapted therefor ([B01J 19/08](#) takes precedence)

Definition statement

This place covers:

Chemical processes and apparatus specially adapted for reacting gases with non particulate solids, e.g. sheet material

Special rules of classification

Reaction of gaseous media with catalytic and inert non-particulate solids, catalytically porous plates is classified in [B01J 15/005](#)

B01J 16/00

Chemical processes in general for reacting liquids with non- particulate solids, e.g. sheet material; Apparatus specially adapted therefor ([B01J 19/08](#) takes precedence)

Definition statement

This place covers:

Chemical processes and apparatus specially adapted for reacting liquids with non particulate solids, e.g.sheet material

Special rules of classification

Reaction of liquids with catalytic and inert non-particulate solids, catalytically porous plates is classified in [B01J 16/005](#)

B01J 19/00

Chemical, physical or physico-chemical processes in general; Their relevant apparatus

Definition statement

This place covers:

Particularly important is the general aspect of the processes and/or apparatus classified in this group. Processes or apparatus for specific applications should be classified in the relevant specific places for these processes or apparatus. An exception of this rule concerns apparatus used for polymerization which should be, in addition to the polymerization subclasses [C08F](#), [C08G](#), also classified in [B01J 19/00](#) Subclasses if specific apparatus features are very relevant.

Relationships with other classification places

Membranes, filters, their composition are classified in [B01D](#) and [C02F](#) if they are used in water treatment. If membrane or filter is used in a general apparatus, it is classified in [B01J 19/00](#) subgroups, e.g. [B01J 19/1893](#), membranes reactors.

References

Application-oriented references

Examples of places where the subject matter of this place is covered when specially adapted, used for a particular purpose, or incorporated in a larger system:

Packings, fillings or grids specially adapted for biological treatment of water, waste water or sewage	C02F 3/10
Physical treatment of fibers, threads, yarns, fabrics, feathers or fibrous goods made from such materials	D06M 10/00
Splashing boards or grids specially adapted for trickle coolers	F28F 25/08

Informative references

Attention is drawn to the following places, which may be of interest for search:

Computational chemistry; Chemoinformatics; Computational materials science	G16C
--	----------------------

Special rules of classification

For classification in [B01J 19/00](#), a large group of Indexing Code [B01J 2219/00](#) has been created; these Indexing Code-codes are very important for search purposes and should be used extensively for classifying additional information.

[B01J 19/0006](#): this subgroup is used mainly in cases where the invention concerns the whole control system, except temperature control (see [B01J 19/0013](#)). For optimisation processes see [B01J 19/0033](#). Documents classified in [B01J 19/0006](#) should be always circulated to [G05B](#).

[B01J 19/004](#): if documents relate to combinatorial chemistry or array manufacture, these documents should be classified only in [B01J 19/0046](#) and [C40B](#) (for arrays as such: [C12Q 2537/00](#)).

[B01J 19/0053](#): this subgroup does not cover ozone making devices (see [B01J 19/088](#) or [C01B](#)).

[B01J 19/008](#): if cavitation is produced by acoustic waves, [B01J 19/10](#) takes precedence. For mixing by cavitation: [B01F](#).

[B01J 19/0086](#): this subgroup also covers general recrystallisation processes. Specific crystallisation processes are covered by [B01D 9/00](#)- [B01D 19/00](#).

[B01J 19/0093](#): documents classified in this subgroup should not be classified in other subgroups, unless it is disclosed that the sizes can be scaled up. Microfluidic devices without any reaction aspect are not covered by this subgroup and should be circulated to [B01L](#). Microdevices for analytic purposes are also not covered by [B01J 19/0093](#) and should be circulated to [G01N](#); micromixers should be circulated to [B01F](#). Microheat-exchangers should be circulated to [F28D 9/00](#) and [F28F 3/00](#).

[B01J 19/088](#): electric discharge ozone generators should not be classified in [B01J 19/088](#) but should be classified in [C01B](#). All other devices for producing ozone, e. g. with plasma production, can be classified in both fields.

[B01J 19/123](#): Fluid treatment with UV should be classified in [B01J 19/123](#) if the nature of the fluid is not specified. For water treatment with UV, [C02F](#) takes precedence.

[B01J 19/18](#): stationary reactors having moving elements inside used for the treatment of waste materials (plastic wastes, organic wastes, hazardous or toxic wastes...) should not be classified in [B01J 19/18](#) but should be classified in the more specific fields like [A62D 3/00](#), [B09C 1/00](#) depending on the kind of waste treated.

[B01J 19/1837](#) and [B01J 19/2435](#): for a polymerization process carried out in a tubular loop-type reactor, [B01J 8/1854](#) should be used instead of [B01J 19/1837](#) or of [B01J 19/2435](#) if solid particles (catalyst, polymer particles...) are present at the beginning of the reaction (the reaction is carried out from the beginning in presence of solid particles).

[B01J 19/30](#) and [B01J 19/32](#): documents relating to [C02F](#) should be classified in [B01J 19/30](#) or [B01J 19/32](#) if the packing aspect, especially geometrical shapes, is relevant (the Indexing Codes [B01J 2219/00](#) should be used).

- Processes with catalytic granular particles are classified in [B01J 8/00](#), unless for a plate-type reactor with catalytic particles between the plates ([B01J 19/249](#) and Indexing Code-code: [B01J 2219/2479](#)) or a monolithic reactor with catalytic particles in the monolithic channels ([B01J 19/2485](#) and Indexing Code-code [B01J 2219/243](#)).

B01J 19/0046

{Sequential or parallel reactions, e.g. for the synthesis of polypeptides or polynucleotides; Apparatus and devices for combinatorial chemistry or for making molecular arrays (synthesis methods per se [C40B 50/00](#))}

Definition statement

This place covers:

Methods and devices in general for the purpose of combinatorial chemistry or the making of combinatorial arrays, e.g. biochips. This implies that a synthesis of a library is performed or is meant to be performed with a device.

It is particularly relevant to note that documents classified in this sub-group relate to general aspects of such methods and devices, such as general process steps, or the physical aspects of bio-chips.

Purely chemical or biochemical aspects, analytical aspects, as well as libraries per sé, are NOT covered by this group

Relationships with other classification places

Combinatorial libraries as such, and many aspects of combinatorial libraries, including synthesis, screening and identification of library members, relating to methods as well as devices, are not covered by this sub-group, but classified in [C07](#), [C12N](#), [C40B](#).

Microfluidic analysis and PCR devices are classified in [B01L](#).

Sampling and analysis devices per se are classified in [G01N](#).

References

Limiting references

This place does not cover:

Peptide libraries	C07K 1/047
Nucleic acid libraries and their screening	C12N 15/1034 and subgroups
Nucleic acid analysis characterised by the use of probe arrays or probe chips.	C12Q 1/6837
Methods for sequencing involving nucleic acid arrays, e.g. Sequencing By Hybridisation	C12Q 1/6874
Combinatorial libraries as such	C40B 40/00 and subgroups
General methods per se for simultaneous synthesis of five or more different organic compounds	C40B 50/00

Application-oriented references

Examples of places where the subject matter of this place is covered when specially adapted, used for a particular purpose, or incorporated in a larger system:

Immunoassays; Biospecific binding assays.(on solid supports)	G01N 33/53 and subgroups (G01N53/543 and subgroups)
--	---

Informative references

Attention is drawn to the following places, which may be of interest for search:

Compounds containing polynucleotide units obtained by (or as intermediates for) chemical engineering	C07H 21/00
Preparation of peptides on supports	C07K 1/04

Special rules of classification

Aspects of methods and devices for combinatorial chemistry classified in [B01J 19/0046](#) are to be classified in the corresponding Indexing Code-codes below [B01J 2219/00274](#)

B01J 19/02

Apparatus characterised by being constructed of material selected for its chemically-resistant properties

References

Informative references

Attention is drawn to the following places, which may be of interest for search:

Refractory details of furnaces	F27D
--------------------------------	----------------------

B01J 19/08

Processes employing the direct application of electric or wave energy, or particle radiation; Apparatus therefor (application of shock waves [B01J 3/08](#))

References**Informative references**

Attention is drawn to the following places, which may be of interest for search:

Generating or handling plasma	H05H 1/00
-------------------------------	---------------------------

B01J 19/10

employing sonic or ultrasonic vibrations

References**Application-oriented references**

Examples of places where the subject matter of this place is covered when specially adapted, used for a particular purpose, or incorporated in a larger system:

Degasification of liquids	B01D 19/0073
Auxiliary pre-treatment of gases or vapours by sounds or ultrasonics	B01D 51/08
Mixing by means of ultrasonic vibrations	B01F 11/02
Cleaning by sonic or ultrasonic vibrations	B08B 3/12

B01J 19/14

Production of inert gas mixtures; Use of inert gases in general

References**Application-oriented references**

Examples of places where the subject matter of this place is covered when specially adapted, used for a particular purpose, or incorporated in a larger system:

Separation of gases or vapours	B01D 53/00
--------------------------------	----------------------------

Informative references

Attention is drawn to the following places, which may be of interest for search:

Apparatus for generating gases	B01J 7/00
Use of inert gas for filling space above liquid or between contents for reducing the vapour space or for reducing the formation of vapours within large containers	B65D 90/44

B01J 19/20**in the form of helices, e.g. screw reactors****References****Informative references***Attention is drawn to the following places, which may be of interest for search:*

Thin-film reactors	B01J 10/02
--------------------	----------------------------

B01J 19/28**Moving reactors, e.g. rotary drums ([B01J 19/08](#) takes precedence)****References****Application-oriented references***Examples of places where the subject matter of this place is covered when specially adapted, used for a particular purpose, or incorporated in a larger system:*

Heat treatments such as calcining using rotating drums	B01J 6/002
Rotary-drum furnaces	F27B 7/00

Informative references*Attention is drawn to the following places, which may be of interest for search:*

Centrifuges	B04B
-------------	----------------------

B01J 20/00**Solid sorbent compositions or filter aid compositions; Sorbents for chromatography; Processes for preparing, regenerating or reactivating thereof****Definition statement***This place covers:*

Solid inorganic or organic materials and compositions useful as adsorbent, as absorbent, as filter aid, as packing or stationary phase for preparative, analytical or investigative chromatography.

Solid sorbent materials or compositions, filter aid materials or compositions, stationary phases for chromatography, in general, characterised by their form or physical properties.

Solid sorbent materials or compositions, filter aid materials or compositions and stationary phases comprising a carrier.

Processes, in general, for preparing solid sorbents, filter aids and stationary phases for chromatography.

Regenerating or reactivating such materials or compositions, in general.

In this group "solid sorbent or filter aid" includes also materials or compositions in semi-solid, paste or gel state.

References

Application-oriented references

Examples of places where the subject matter of this place is covered when specially adapted, used for a particular purpose, or incorporated in a larger system:

Chromatography involving ion exchange	B01D 15/361
Liquid absorbents for use in the separation of gases	B01D 53/14
Ion-exchangers used in processes for treating water	C02F 1/42 - C02F 2001/427

Informative references

Attention is drawn to the following places, which may be of interest for search:

Ion exchange materials or ion exchange processes	B01J 39/00 - B01J 49/90
Animal litters.	A01K 1/0152
Treatment of milk	A23C 9/14
Removal of unwanted matter from foods or foodstuffs, e.g. deodorisation , detoxification using adsorption or absorption agents, resins, synthetic polymers , or ion exchangers	A23L 5/273
Deodorant compositions containing sorbent material, e.g. activated carbon	A61L 9/014
Super-absorbents or liquid swellable gel forming materials used in absorbent pads.	A61L 15/60
Processes for treating blood in an extra-corporeal blood circuits involving sorbents.	A61M 1/3679
Liquid absorbents for solvent extraction processes, i.e. separating processes involving the treatment of liquids with liquid	B01D 11/00
Processes and apparatus involving the treatment of liquids in general with solid sorbents.	B01D 15/00 - B01D 15/428
Processes of filtration by addition of filter aids to the liquid being filtered.	B01D 37/02
Processes involving the treatment or separation of gases with adsorbents.	B01D 53/02
Compounds per se, see the relevant classes	C01 , C07 , C08
Uptaking or getter material for reversible uptake of hydrogen	C01B 3/001
Processes involving the treatment of water with sorbents.	C02F 1/28 - C02F 1/288
Purification of hydrocarbons by adsorption.	C07C 7/12
Separation or purification of peptides by chromatography.	C07K 1/16
Materials used for absorbing liquid pollutants, e.g. oil, gasoline, fat.	C09K 3/32
Processes for refining hydrocarbon oils involving solid sorbents.	C10G 25/00
Working-up used lubricants with the use of sorbents.	C10M 175/0008
Clarification materials used in the clarification of alcoholic beverages.	C12H 1/04
Processes for the isolation, preparation or purification of DNA or RNA	C12N 15/10
Purification of sugar juices using sorbents	C13B 20/12
Extraction of metals from ores or concentrates by wet processes.	C22B 3/00

Recovery of noble metals from waste materials from spent catalysts using solid sorbents, e.g. getters or catchment gauzes	C22B 11/028
Gas sorbents in vessels, e.g. for storage.	F17C 11/00
Boiler-absorbers, i.e. boilers usable for absorption or adsorption using a solid as sorbent	F25B 35/04
Drying solid materials or objects by processes not involving the application of heat by contact with sorbent bodies, e.g. adsorbent mould; by admixture with sorbent materials	F26B 5/16
Controlling humidity by using sorbent or hygroscopic materials in arrangements for supplying and controlling air or gases for drying solid materials or objects	F26B 21/083
Preparing specimens for investigating by concentrating samples using adsorption or absorption	G01N 1/405
Investigating or analysing materials by separation into components using adsorption, absorption or similar phenomena or using ion-exchange, e.g. chromatography	G01N 30/00 , G01N 30/96
Treatment of radioactively contaminated liquids using sorbents.	G21F 9/12
CO ₂ capture by adsorption	Y02C 10/08

Special rules of classification

Pure compounds or elements are classified in the appropriate subclass for chemical compounds or elements. When it is explicitly stated that a solid pure inorganic or organic compound or element is useful as a sorbent, filter aid, packing or stationary phase for chromatography, it is further classified in [B01J 20/00-B01J 20/3491](#).

- In groups [B01J 20/00-B01J 20/3491](#), in the absence of an indication to the contrary, classification is made in the last appropriate place.
- In some cases, multiple classification should be applied:

In the case of documents relating to different solid sorbents, filter materials or stationary phases as alternatives or relating to compositions of several of these components, each sorbent or component should be classified in the appropriate place within [B01J 20/00-B01J 20/3491](#).

Use of solid sorbent materials or compositions are also further classified in the corresponding appropriate classes.

- Sorbents specially useful for preparative, analytical or investigative chromatography, e.g. stationary phases, are classified in [B01J 20/281-B01J 20/292](#).

The Indexing Code symbol [B01J 2220/54](#) should also be used when the stationary phase is used for analytical or investigative chromatography.

- [B01J 20/30](#) is used for classifying processes for preparing sorbents. [B01J 20/30](#) should only be used for particular processes wherein the sorbent prepared is irrelevant or not well defined. The preparation process of a well defined sorbent should be classified in the appropriate group corresponding to the sorbent [B01J 20/02-B01J 20/292](#).
- However, sorbents or stationary phases and their preparation involving coating, impregnating, e.g. coating, impregnating by modifying or functionalizing a carrier, should both be classified in [B01J 20/32-B01J 20/3297](#).
- Regeneration or reactivation of sorbents should be classified in [B01J 20/34-B01J 20/3491](#).

B01J 20/20

comprising free carbon; comprising carbon obtained by carbonising processes

References**Informative references**

Attention is drawn to the following places, which may be of interest for search:

Active carbon	C01B 32/30
---------------	----------------------------

B01J 21/00

Catalysts comprising the elements, oxides, or hydroxides of magnesium, boron, aluminium, carbon, silicon, titanium, zirconium, or hafnium

Definition statement

This place covers:

Catalysts comprising the elements, oxides, or hydroxides of magnesium, boron, aluminium, carbon, silicon, titanium, zirconium, or hafnium

References**Limiting references**

This place does not cover:

Electrocatalysts, electrodes	H01M
------------------------------	----------------------

Special rules of classification

See the Special rules of classification of [B01J](#)

B01J 21/04**Alumina****References****Informative references**

Attention is drawn to the following places, which may be of interest for search:

Alumina per se	C01F 7/02
----------------	---------------------------

B01J 21/063

{Titanium; Oxides or hydroxides thereof}

References**Informative references**

Attention is drawn to the following places, which may be of interest for search:

Photocatalysts	B01J 35/004
----------------	-----------------------------

Titania per se	C01G 23/047
----------------	-----------------------------

B01J 21/066

{Zirconium or hafnium; Oxides or hydroxides thereof}

References**Informative references**

Attention is drawn to the following places, which may be of interest for search:

Zirconia per se	C01G 25/02
-----------------	----------------------------

B01J 21/16

Clays or other mineral silicates

References**Limiting references**

This place does not cover:

Pillared clays	B01J 29/049
----------------	-----------------------------

B01J 21/20

Regeneration or reactivation

Special rules of classification

Regeneration processes may additionally be classified in [B01J 38/00](#), if details of the regeneration process are disclosed

B01J 23/00

Catalysts comprising metals or metal oxides or hydroxides, not provided for in group [B01J 21/00](#) ([B01J 21/16](#) takes precedence)

References**Limiting references**

This place does not cover:

Electrocatalysts, electrodes	H01M
------------------------------	----------------------

Special rules of classification

See the Special rules of classification of [B01J](#)

B01J 23/002

{Mixed oxides other than spinels, e.g. perovskite}

Special rules of classification

Mixed oxides containing 3 or more elements (excluding oxygen) are classified in the appropriate class, and the examples are additionally classified as [B01J 2523/00](#)+[\[B01J 2523/00\]](#)/...+/, where each element constituting the exemplified mixed oxide is indexed using the relevant classification symbols of [B01J 2523/00](#) - [B01J 2523/847](#), in numerical order without [B01J 2523/00](#) and preceded by the sign "+", e.g. Moa Vb Tec Ox [B01J 2523/00](#)+ /55+ /64+ /68

B01J 23/007

{Mixed salts}

References

Informative references

Attention is drawn to the following places, which may be of interest for search:

Hydroxy carbonates	B01J 27/236
Hydrotalcite per se	C01F 7/005

Special rules of classification

Hydrotalcites obtained as intermediate, later converted to other structures, may be indexed using an Indexing Code.

Synonyms and Keywords

In patent documents, the following words/expressions are often used as synonyms:

- "hydrotalcite", "anionic clay", "HT" and "HTc"

B01J 23/04

Alkali metals

Definition statement

This place covers:

Catalysts comprising magnesium

B01J 23/10

of rare earths

References

Informative references

Attention is drawn to the following places, which may be of interest for search:

Zr-Ce mixed oxides per se	C01G 25/00
---------------------------	----------------------------

B01J 23/58**with alkali- or alkaline earth metals****Definition statement***This place covers:*

Catalysts comprising platinum group metals with magnesium.

B01J 23/78**with alkali- or alkaline earth metals****Definition statement***This place covers:*

Catalysts comprising iron group metal or copper with magnesium.

B01J 23/90**Regeneration or reactivation****Special rules of classification**

Regeneration processes may additionally be classified in [B01J 38/00](#), if details of the regeneration process are disclosed

Regeneration or reactivation relates to any type of catalyst

Regeneration or reactivation of catalysts comprising metals, oxides or hydroxydes provided in groups [B01J 13/02](#) - [B01J 23/36](#) are classified in [B01J 23/92](#)

Regeneration or reactivation of catalysts comprising metals, oxides or hydroxides of the iron group metals or copper are classified in [B01J 23/94](#)

Regeneration or reactivation of catalysts comprising metals, oxides or hydroxides of the nobles metals are classified in [B01J 23/96](#)

B01J 25/00**Catalysts of the Raney type****Definition statement***This place covers:*

Catalysts of the Raney type, i.e. catalysts prepared by leaching of an alloy to produce porous structure, such as by dissolving aluminium from alloy using a base such as NaOH.

References**Limiting references***This place does not cover:*

Electrocatalysts, electrodes	H01M
------------------------------	----------------------

Special rules of classification

See the Special rules of classification of [B01J](#)

Synonyms and Keywords

In patent documents, the following words/expressions are often used as synonyms:

- "Raney catalyst", "sponge-metal catalyst" and "skeletal catalyst"

B01J 25/04

Regeneration or reactivation

Special rules of classification

Regeneration processes may additionally be classified in [B01J 38/00](#), if details of the regeneration process are disclosed

B01J 27/00

Catalysts comprising the elements or compounds of halogens, sulfur, selenium, tellurium, phosphorus or nitrogen; Catalysts comprising carbon compounds

References

Limiting references

This place does not cover:

Electrocatalysts, electrodes	H01M
------------------------------	----------------------

Special rules of classification

Metal catalysts or metal oxide catalysts activated or conditioned by halogens, sulfur or phosphorus, or compounds thereof are classified in the appropriate groups for metal or metal oxide catalysts ([B01J 23/00](#)) and in the groups relevant for activation / conditioning ([B01J 37/00](#)).

See also special rules of classification in [B01J](#)

B01J 27/188

with chromium, molybdenum, tungsten or polonium

Special rules of classification

Heteropolyacids are classified in [B01J 27/188](#) and subgroups, even if no phosphorus is present, in which case the regular class is additionally given (e.g. $H_4[W_{12}SiO_{40}]$ is classified in [B01J 23/30](#) and [B01J 27/188](#))

B01J 27/236

Hydroxy carbonates

References

Informative references

Attention is drawn to the following places, which may be of interest for search:

Mixed salts	B01J 23/007
Hydrotalcite per se	C01F 7/005

Special rules of classification

Hydrotalcites are classified in [B01J 23/007](#)

B01J 27/26**Cyanides****References****Informative references**

Attention is drawn to the following places, which may be of interest for search:

[C08G 65/2663](#), [C01C 3/08](#), [C01C 3/10](#), [C01C 3/11](#), [C01C 3/12](#), [C01C 3/002](#)

Synonyms and Keywords

In patent documents, the following abbreviations are often used:

DMC	Double Metal Cyanide
-----	----------------------

B01J 27/28**Regeneration or reactivation****Definition statement**

This place covers:

Regeneration or reactivation of catalysts comprising elements or compounds of halogens, sulfur, selenium, tellurium, phosphorous, nitrogen or catalysts comprising carbon compounds

Special rules of classification

Regeneration processes may additionally be classified in [B01J 38/00](#), if details of the regeneration process are disclosed

B01J 29/00**Catalysts comprising molecular sieves {(molecular sieves per se [C01B](#))}****References****Limiting references**

This place does not cover:

Electrocatalysts, electrodes	H01M
------------------------------	----------------------

Special rules of classification

Aspects of molecular sieve catalysts relating to after treatment, such as dealumination, or synthesis on support, are indexed with codes selected from [B01J 2229/00](#)

See also special rules of classification in [B01J](#)

B01J 29/005

{Mixtures of molecular sieves comprising at least one molecular sieve which is not an aluminosilicate zeolite, e.g. from groups [B01J 29/03](#) - [B01J 29/049](#) or [B01J 29/82](#) - [B01J 29/89](#)}

References

Informative references

Attention is drawn to the following places, which may be of interest for search:

Mixtures containing only aluminosilicate zeolites	B01J 29/80
---	----------------------------

Special rules of classification

Mixtures of containing one or more molecular sieves which are not a (aluminosilicate) zeolite are classified here, and their constituents are classified individually with the corresponding [B01J 29/00](#)-Indexing Codes

B01J 29/80

Mixtures of different zeolites

References

Informative references

Attention is drawn to the following places, which may be of interest for search:

Mixtures containing one or more molecular sieves, which are not (aluminosilicate) zeolites	B01J 29/005
--	-----------------------------

Special rules of classification

Mixtures of (aluminosilicate) zeolites are classified here, and their constituents are classified individually with the corresponding [B01J 29/00](#)-Indexing Codes

B01J 29/90

Regeneration or reactivation

Definition statement

This place covers:

Regeneration or reactivation of catalysts comprising molecular sieves

Special rules of classification

Regeneration processes may additionally be classified in [B01J 38/00](#), if details of the regeneration process are disclosed

Glossary of terms

In this place, the following terms or expressions are used with the meaning indicated:

Regeneration, Reactivation	a substance microscopically dispersed evenly throughout another substance. The colloidal system, which may be solid, liquid or gaseous, has a very high stability, i.e. precipitation does not occur under the influence of gravity.
Microcapsule	a core-shell particle with a stable, non-transient shell

B01J 31/00

Catalysts comprising hydrides, coordination complexes or organic compounds (catalyst compositions used only in polymerisation reactions [C08](#) {; catalytic antibodies [C12N 9/0002](#)})

Definition statement

This place covers:

Catalysts comprising:

- organic compounds ([B01J 31/02](#)), including ionic liquids ([B01J 31/0277](#)), polymers ([B01J 31/06](#)) or polymeric ion exchangers ([B01J 31/08](#));
- metal hydrides or organometallic compounds ([B01J 31/12](#)), including organometallic polymers ([B01J 31/123](#));
- coordination complexes ([B01J 31/16](#)), including coordination polymers or metal organic frameworks (MOF) ([B01J 31/1691](#));
- in addition to any of the above further inorganic metal compounds ([B01J 31/26](#)), e.g. metal halides.

The meaning of the term "catalyst" within this group encompasses catalyst systems, i.e. additives essential to the catalytic function of such systems are also included in this group, e.g. co-catalysts, specific reagents, solvents or solvent mixtures.

Further covered by this group is:

Regeneration or reactivation of such catalysts, catalyst systems or constituents thereof, e.g. metal, ligand ([B01J 31/40](#)) by chemical and/or physical means, e.g. membrane separation ([B01J 31/4061](#)), extraction with special solvents ([B01J 31/4069](#)), electrochemical processes ([B01J 31/4076](#)).

Relationships with other classification places

A material is classified as catalyst when the application states that it is useful as catalyst (or catalyst support) and when details regarding its composition, properties, preparation or regeneration are disclosed.

Compounds per se are classified in subclasses [C07C](#) - [C07F](#). This compound classification is also (additionally) applied in cases where multiple possible uses from distinct chemical fields are disclosed in the application, e.g. as catalysts, sorbents or medicinal agents.

Catalysts only used as electrocatalysts are not classified in [B01J](#) but in [H01M](#).

In contrast to apparatuses used for polymerisation processes classified in [C08F](#) and [C08G](#), the relevant catalysts should not be classified in [B01J](#), in particular not in [B01J 31/00](#), since these, as well as further polymerisation process features are covered in the polymer subclasses of [C08](#). Indexing using Indexing Codes [B01J 31/00](#) may however be made to provide non-obligatory further information of potential interest for search purposes.

Multiple classification

The intended use of the catalysts of this group is preferably classified as well, e.g. in a group of [C07B](#) - [C07D](#).

Separately claimed ligands of metal complexes should be classified in a group of [C07C](#) - [C07F](#).

Any part of a catalyst which is not identified by the classification according to the point above, and which is considered to represent information of interest for search, may also be classified. This can, for example, be the case when it is considered of interest to enable searching of catalysts using a combination of classification symbols. Such non-obligatory classification should be given Indexing Codes as "additional information"

References**Limiting references**

This place does not cover:

Double metal cyanide (DMC) catalysts	B01J 27/26
--------------------------------------	----------------------------

Application-oriented references

Examples of places where the subject matter of this place is covered when specially adapted, used for a particular purpose, or incorporated in a larger system:

Gas treating using catalysts	B01D 53/86 , B01D 53/94
Catalyst compositions used only in polymerisation reactions	C08 , C08F 4/00
Metal complexes in liquid carbonaceous fuels	C10L 1/30
Metal complexes as bleach catalysts in detergent compositions	C11D 3/168
Catalytic antibodies	C12N 9/0002
Electrocatalysts	H01M

Informative references

Attention is drawn to the following places, which may be of interest for search:

Catalysts comprising inorganic constituents or molecular sieves	B01J 21/00 - B01J 29/00
Catalysts comprising inorganic carbon compounds	B01J 27/20 - B01J 27/26
Protection of catalysts, e.g. of Raney catalysts	B01J 33/00
Catalysts characterised by their form or physical properties	B01J 35/00
General processes for catalyst preparation or activation, e.g. impregnation, coating, reducing	B01J 37/00
General processes for catalyst regeneration or reactivation	B01J 38/00
Ion-exchange processes and apparatus, per se	B01J 39/00 - B01J 49/00
General methods of organic chemistry	C07B
C-C cross-coupling reactions	C07B 37/04
Acyclic or alicyclic organic compounds per se, their preparation	C07C
Hydroformylation (oxo-reaction)	C07C 45/50
Preparation of metal complexes, including MOFs, containing carboxylic acid moieties	C07C 51/418
Heterocyclic organic compounds per se, their preparation	C07D

Epoxidation (preparation of oxiranes)	C07D 301/00
Organic non-metal and metal compounds per se, including organometallic compounds and complexes, of groups 1–18 of the periodic table	C07F
Metal-organic frameworks (MOFs)	C07F 19/005
Metal complexes as synthetic dyes	C09B 57/00

Special rules of classification

In this group, in the absence of an indication to the contrary, classification is made in the last appropriate place ("last place rule"). Classification is further made according to the reformed ECLA approach, i.e. important (invention-related) information is identified with ECLA classification symbols, e.g. [B01J 31/02](#), other (secondary) information with Indexing Code symbols, e.g. [B01J 31/02](#), from a "mirrored" Indexing Code scheme.

The distinction between "compound" and "coordination complex" is made according to the definitions in the glossary below; in case of doubt, the more probable case can be classified with ECLA symbols, e.g. [B01J 31/223](#), while the other case is additionally indexed with the appropriate Indexing Codes from [B01J 31/00](#), e.g. [B01J 31/0211](#). The wording in the application should also be considered. Thus in absence of exact identification of substances by name, formula or registry number, if reference is made exclusively to "complexes" and this designation appears correct on the basis of probability the catalyst in question should be classified as coordination complex.

In this group, if two or more aspects are of equal importance, these are each classified, e.g. two components in a catalyst system such as:

- support and pendant or otherwise immobilised coordination complex;
- MOF and all linking ligands;
- coordination complex and essential additive; or
- coordination complex and further catalytically active metal components, e.g. nanoparticles.

However, if two components, even if separately added, are described as forming, or known to form, a coordination complex, only the latter is classified, e.g. phosphine and Group 8-10 metal such as rhodium. The groups [B01J 31/26](#) - [B01J 31/38](#) are not to be used for the central metals in coordination complexes but rather for separately added further inorganic ingredients.

Likewise, the catalyst (system) and its regeneration method (see groups [B01J 31/40](#)), if defined in sufficient detail, would both be classified.

The further catalyst groups of [B01J](#), i.e. [B01J 21/00](#)-[B01J 38/00](#) can be used to classify such further aspects of materials and processes to be used, if not provided in sufficient detail in [B01J 31/00](#), e.g. when a specially prepared inorganic support or a support with specific physical parameters or a special form is concerned. Further guidance in this respect is given in the classification rules for [B01J 21/00](#) - [B01J 29/00](#) and [B01J 32/00](#) - [B01J 38/00](#).

Each specifically disclosed alternative is separately classified, i.e. specifically disclosed by way of worked examples, specific claims and/or explicit alternatives therein. This applies even if the application does not claim a catalyst per se.

In the case of compounds of this group, and in analogy to the guidance given in subclass [C07C](#) (cf. respective classification rules), this means either real examples of claimed compounds, i.e. those which are prepared or for which physical data, preparation or regeneration details are given, and compounds which are individually named or drawn in the claims.

Conversely long lists ("shopping lists") of prophetic compounds which fall within the scope of the claims but which have not actually been prepared and characterised or at least individually claimed

are not classified. Neither are individual compounds generated only via Markush enumerations of generic formulae classified.

All examples are classified individually. Even if classification of the "fully identified" compounds would lead to the assignment of a large number of subgroups, no generalisation to the next hierarchically higher level is made. However, in case the claims relate to a catalyst and if classification of the examples only does not suitably reflect the subject-matter of the claims, additional, general classes are given to cover the scope of the catalyst claims.

When classifying in [B01J 31/00](#), additional information for the catalysts is provided as follows:

- the specifically disclosed intended uses are indexed in [B01J 2231/00](#);
- general aspects of the complexes of group [B01J 31/16](#), e.g. polynuclearity, ligand type, metal bonding mode(s) and the specifically disclosed central metal(s) therein, as well as additional information regarding any special solvents used for any catalyst system of this class are indexed in [B01J 2531/00](#);
- if expedient further compositional aspects of such complexes, e.g. non-coordinating substituents on the ligand described as essential and explicitly mentioned in the claims or the worked examples, are indexed in [B01J 2540/00](#); and
- conceptual articles, e.g. reviews, are separately indexed in [B01J 2231/005](#) and [B01J 2531/001](#).

Example:

A metal-organic framework would be classified in group [B01J 31/1691](#), the principal ligands (e.g. dicarboxylate, bipyridine, pyrazine, dabco) would furthermore be classified with the appropriate groups from [B01J 31/00](#), e.g. [B01J 31/2239](#) for dicarboxylate linkers;

the orthogonal Indexing Code terms [B01J 2531/0205](#) - [B01J 2531/0222](#), would then be used to define the respective catalyst (component) further according to the respective SBU comprising the metal, e.g.:

- tetrahedral $[Zn_4O]$ in MOF-5 and the IRMOF series => term is [B01J 2531/0216](#) since a bi- or polynuclear complex, without metal-carbon bonds, is involved;
- paddle-wheel $[Cu_2(O_2CR)_4]$, comprising a Cu-Cu bond, present in typical copper-based MOFs, e.g. $[Cu_2(1,4\text{-}bdc)_2](4,4'\text{-}bipy)$ => term is [B01J 2531/0219](#), since a bimetallic complex, without metal-carbon bonds, is involved.

Glossary of terms

In this place, the following terms or expressions are used with the meaning indicated:

Catalyst	Covers also a carrier forming part of the catalyst, specific additives and co-catalysts.
Organic compound	a compound in which carbon is bonded to - a second carbon;- at least one atom of hydrogen or halogen; or - nitrogen by a single or double bond;except cyanic acid (HOCN), cyanogen (NCCN), cyanamide (H ₂ NCN), cyanogen halide (HalCN), hydrocyanic acid (HCN), isocyanic acid (HNCO), fulminic acid (HCNO) and metal carbides (MCCM).
Organic ligand	a carbon-containing ligand bonded to a central metal in which said carbon is bonded to - a second carbon;- at least one atom of hydrogen or halogen; or - nitrogen by a single or double bond;except cyanic acid (HO-C≡N), cyanogen (N≡C-C≡N), cyanamide (H ₂ N-C≡N), cyanogen halide (Hal-C≡N), hydrocyanic acid (HC≡N), isocyanic acid (HN=C=O), fulminic acid (HC≡N-O), carbides (C≡C) and the respective anionic ligands derived by deprotonation (O-C≡N, N=C=N, C≡N, N=C=O, C≡N-O).

Organometallic compounds	all organic compounds wherein a metal or metalloid atom is bonded directly to a carbon fragment, the latter being formally anionic, no further neutral ligands being coordinated to the metal and the compound requiring no further cations for charge balance; e.g. $M(CR_3)_n$ with M = main group metal, n = valency of metal and R = H or hydrocarbyl.
Coordination complexes	all donor-acceptor compounds or complex ions comprising organic or inorganic, anionic or neutral Lewis basic ligands, attached to a Lewis acid central metal or metal ion through one or several complexing donor atoms with at least one lone-pair of electrons, e.g. N, O, S, P, to provide at least a sigma-bond; typically the maximum number of same or different ligands according to the coordination number, spatial requirements of the ligand and electronic configuration of the metal is bound in a predictable geometry; complexes of neutral, cationic or anionic hydrocarbon ligands with delocalised charge and/or bonding site, e.g. Pd-olefin complexes or metallocenes, are also included.
Organometallic complexes	all coordination complexes comprising a M-C bond, e.g. metal carbonyls; included are furthermore complexes which are not strictly organometallic per se, e.g. comprising only N, O, S and/or P coordinated ligands, but are described as involving, or known to involve, organometallic intermediates and/or transition states during use, e.g. Group 8-10 metal complexes for a variety of catalytic reactions or steps thereof, such as oxidative addition, e.g. of ArX , hydrogenation, carbonylation, epoxidation.
Organic complexes	all coordination complexes comprising organic ligands.
Polymer	a macromolecular substance (typically $M > 10000$ g/mol) comprising repeating units made up of one or several kinds of atoms or groups of atoms, which are identically connected to one another.
Oligomer	compound with more than two identical repeating units connected to one another and typically 500 less than M less than 10000 g/mol; grouped with the respective polymers
Ionic liquid	an organic salt in the liquid state at the reaction temperature employed, e.g. less than or equal to 100 °C or less than or equal to 20 °C ("room-temperature ionic liquid")
Metal-organic framework	crystalline compounds consisting of metal ions or clusters coordinated to often rigid organic molecules as linkers to form one-, two-, or three-dimensional structures; see e.g. reviews: - O. Yaghi et al., Nature 423 (2003) 705-714 (XP2392829), - M.J. Rosseinsky, Micropor. Mesopor. Mat. 73 (2004) 15-30 (XP4522127); the linkers are often dicarboxylates, the metals often Zn, Cu, Fe or Al.
Carbenes (Carbynes)	a metal coordination complex comprising a formally divalent (trivalent) ligand with a neutral carbon atom bonded to the metal via two (three) unshared electrons, i.e. a formal derivative of the hypothetical ligand CR_2 (CR), the electrons may be paired or not.
N-Heterocyclic carbene	a saturated or unsaturated heterocyclic compound comprising a neutral carbon atom with a lone electron pair (in the typical case of singlet or "nucleophilic" carbenes) adjacent to at least one nitrogen atom.

Bi- or polynuclear complex	a coordination complex comprising two or more same or different metal atoms, without M-M bonds; e.g. Cp(Lx)Zr-imidazole-Zr(Lx)Cp, [R ₂ PCp-Fe-CpPR ₂]Rh(L) _n , [(salen)Co(III)]SbF ₆ , Co(II)(salen)Fe(II)Cl ₂ .
Bimetallic complex	a discrete coord. complex comprising one or more units of two metals, same or different, with metal-metal bonds but no all-metal (M) _n rings, e.g. Cr ₂ (OAc) ₄ , [(Mo ₂) ₄ (MeOPhNCNPhOMe) ₈ (Ph(COO) ₂) ₄], [Ph ₂ P-X-PPh ₂]Pt(Cl)SnCl ₃ , [Cp(CO) ₂ Mn=] ₂ Pb.
Metal cluster	a coordination complex with 3 to abt. 1000 same or different metal atoms and further comprising M-M bonds to provide (M) _n rings, i.e. size range from atomic to colloid dimensions; e.g. Rh _x (CO) _y , [R ₃ P=N=PR ₃] ⁺ [Ru ₃ Ir(CO) ₁₃] ⁻ , [Rh ₃ (DIPAMP) ₃ (μ ₃ -OMe) ₂]BF ₄ , Pt ₄ (OAc) ₈ , "Pd(OAc) ₂ " = Pd ₃ (OAc) ₆ .

Synonyms and Keywords

(RT)IL	(room-temperature) ionic liquid
MOF	metal-organic framework
Acac	acetylacetonate
NHC	N-heterocyclic carbene
Cp	cyclopentadienyl
Cp*	pentamethyl cyclopentadienyl

In patent documents the words "phosphanes" and "phosphines" are often used as synonyms, as are "N-heterocyclic carbene" and any member of the family of 1,3-dihydrocarbylimidazoline-2-ylidenes or its saturated imidazolidine analogue.

B01J 31/02

containing organic compounds or metal hydrides

Definition statement

This place covers:

[B01J 31/02](#) - [B01J 31/0274](#): Catalysts comprising simple organic compounds as components of a catalyst system (e.g. solvent or additive) or catalysts per se (e.g. sulfonic acids), which can contain the heteroatoms (i.e. elements other than carbon or hydrogen) defined in [B01J 31/0201](#) - [B01J 31/0255](#) or other heteroatoms ([B01J 31/0272](#)), with the exception of metal atoms as heteroatoms (see [B01J 31/12](#)).

[B01J 31/0277](#) - [B01J 31/0298](#): Catalysts comprising ionic liquids, as components in catalyst systems or catalysts per se, the ionic liquid compounds being used in the molten state at the respective reaction temperature. Compounds likewise being organic onium salts but only used in the solid or dissolved state in multiphase mixtures (e.g. phase-transfer catalysts) and/or with melting points at temperatures above those normally used in organic synthesis (i.e. > 200 °C) would not be classified here but rather in the catalyst compound subgroups of [B01J 31/02](#) - [B01J 31/0274](#).

[B01J 31/04](#): Catalysts comprising carboxylic acids or their salts, with the exception of multi-metal carboxylate complexes like "Pd(II)acetate", i.e. Pd₃(OAc)₆ or "Cr(II)acetate", i.e. Cr₂(OAc)₄ and ionic liquids with carboxylate counter-anions (see [B01J 31/0277](#)).

[B01J 31/06](#) - [B01J 31/10](#): Catalysts comprising polymers and/or oligomers without metal-carbon bonds, including (sulfonated) ion-exchange resins.

[B01J 31/12](#) - [B01J 31/146](#): Catalysts comprising organometallic compounds, including organometallic polymers and metal hydrides.

References

Limiting references

This place does not cover:

Catalysts comprising coordination complexes	B01J 31/16 - B01J 31/24
Multi-metal carboxylate complexes with bridging ligands	B01J 31/2226

Special rules of classification

[B01J 31/02](#) - [B01J 31/0274](#): The last place rule is applied for the catalysts of this subgroup. It is applied in the following manner when two or more different heteroatoms or functional groups are present in one compound:

- The heteroatom furthest down in the scheme is classified first by choosing an appropriate functional group, or the generic element subgroup, i.e. [B01J 31/0215](#), [B01J 31/0234](#), [B01J 31/0235](#), [B01J 31/0255](#), [B01J 31/0272](#) if none is available.
- Next the respective subgroup, within the subgroups of the chosen element/functional group, designating further heteroatoms/functional groups is allocated ([B01J 31/0229](#), [B01J 31/0232](#), [B01J 31/0271](#) or [B01J 31/0275](#)), should heteroatoms outside of the scope of the chosen functional group remain (e.g. subgroups [B01J 31/0222](#) and [B01J 31/0225](#) cover certain S-O combinations, likewise [B01J 31/0245](#)). In the case of halogen being the heteroatom furthest down in the scheme, only this group is allocated (i.e. not both [B01J 31/0231](#) and [B01J 31/0232](#)), unless perfluorinated sulfonyl or sulfonic acid functional groups are concerned (=> groups [B01J 31/0224](#), [B01J 31/0227](#)).
- Next the appropriate functional group or the generic element subgroup for the second heteroatom is allocated.
- If further heteroatoms or functional groups are present, the preceding step is repeated as often as needed, i.e. only the groups corresponding to the further functional groups/elements are added.

Additional indexing is provided for by codes [B01J 2531/90](#) - [B01J 2531/985](#) for special (essential) solvent (systems), e.g. supercritical solvent (mixtures), fluorinated or aqueous solvents, as well as for solvent systems used in phase-transfer catalysis. Catalysts designated as phase transfer catalysts are hence additionally indexed under [B01J 2531/98](#) or [B01J 2531/985](#).

[B01J 31/0277](#) - [B01J 31/0298](#): The last place rule is applied in the same way as for [B01J 31/02](#) - [B01J 31/0274](#), however starting from the appropriate cationic centre (cf. [B01J 31/0278](#) - [B01J 31/0289](#)). Thus the symbols from [B01J 31/02](#) - [B01J 31/0274](#) are also used to classify multifunctional "task specific" ionic liquids. As in the case of [B01J 31/02](#) - [B01J 31/0274](#), the designation of further heteroatoms/functional groups is allocated only once, i.e. by way of [B01J 31/0285](#) or [B01J 31/0291](#). Additional subgroups should be allocated in case of a single, or at most very limited selection of, claimed counter-ions (i.e. not when "shopping lists" of explicit ions are claimed): [B01J 31/0298](#), or when (special) supports are disclosed or claimed: [B01J 31/0292](#) - [B01J 31/0297](#).

[B01J 31/04](#): If deemed expedient, carboxylate complexes to be classified in [B01J 31/2226](#) and subgroups can additionally receive an Indexing Code symbol [B01J 31/04](#) as additional, search relevant information.

Glossary of terms

In this place, the following terms or expressions are used with the meaning indicated:

Organic compound	a compound in which carbon is bonded to - a second carbon;- at least one atom of hydrogen or halogen; or - nitrogen by a single or double bond;except cyanic acid (HOCN), cyanogen (NCCN), cyanamide (H ₂ N ₂ CN), cyanogen halide (HalCN), hydrocyanic acid (HCN), isocyanic acid (HNCO), fulminic acid (HCNO) and metal carbides (MCCM).
Metal amide	M ⁺ [NR ₂] ⁻
Metal guanidide	M ⁺ [RNC(NR ₂)NR] ⁻ and isomers
Onium salt	salts of cations derived by the protonation of mononuclear parent hydrides of a pnictogen (Grp. 15), chalcogen (Grp. 16), or halogen (Grp. 17), their hydrogen substitution derivatives R, typ. organic radicals or halogens, e.g. tetramethylammonium, and further derivatives having polyvalent additions, e.g. iminium, nitrilium.
Ionic liquid	an organic, typ. onium salt in the liquid state at the reaction temperature employed, e.g. ≤ 100 °C or ≤ 20 °C ("room-temperature ionic liquid")

Synonyms and Keywords

In patent documents, the following abbreviations are often used:

EO	ethylene oxide, oxirane
PO, PPO	propylene oxide, methyl oxirane
OTf	triflate, trifluoromethanesulfonate
OMs	mesylate, methanesulfonate
TBAB	tetrabutylammonium bromide
(RT)IL	(room-temperature) ionic liquid
Bmim	ionic liquids: 1,3-butyl- methylimidazolium cation
Emim	ionic liquids: 1,3-ethyl- methylimidazolium cation
NTf ₂	ionic liquids: bistriflimide anion
HMDS	hexamethyldisilazane, Me ₃ Si-NH-SiMe ₃

In patent documents, the following words/expressions are often used as synonyms:

- "metal esters", "metal alkoxides" and "metal ethers"

B01J 31/06

containing polymers {(organometallic polymers [B01J 31/123](#); polymer-bound organometallic complexes [B01J 31/165](#); coordination polymers [B01J 31/1691](#))}

Definition statement

This place covers:

Catalysts containing polymers and/or oligomers without metal-carbon bonds, including (sulfonated) ion-exchange resins.

Relationships with other classification places

In contrast to the "oligomer" definition in [C07C](#) (up to 10 repeating units), the definition used in this group is more than two repeating units and a molecular weight of between about 500 and 10 000 g/mol. Furthermore, in this group oligomers are grouped with the respective polymers, whereas in [C07C](#) they are grouped with low-molecular weight compounds.

References

Limiting references

This place does not cover:

(Sulfonated) Ion-exchange resins	B01J 31/08 (B01J 31/10)
Organometallic polymers	B01J 31/123
Polymer-bound organometallic complexes	B01J 31/165
Coordination polymers	B01J 31/1691

Informative references

Attention is drawn to the following places, which may be of interest for search:

Ion-exchange resins in ion-exchange per se	B01J 39/00 , B01J 41/00
Polymers, polymerisation catalysts	C08

Special rules of classification

In this subgroup, oligomers are grouped with the respective polymers, i.e. with the polymers constituted of the same monomers.

Example:

An alkoxylation catalyst of the following preferred structure,



and the definition:

"wherein t is from 1 to 15, preferably from 1 to 10, more preferably from 1 to 7. Particularly preferred ethoxylated/propoxylated species coming within Formula IV which are useful in the present invention are those wherein R₁ contains from 8 to 14 carbon atoms, p is from 2 to 6 and t is from 1 to 3, most preferably from 1 to 1.5"

would overlap with the oligomer range (see Glossary), since MW of cat B = 536 (with R₁ = C₁₄ alkyl, p=6, t=1) => oligomer and therefore to be classified as polymer, i.e. [B01J 31/068](#) (a polyalkylene glycol), cf. WO2007/030277.

The subgroup [B01J 31/063](#) is reserved for polymers with a precisely defined and special microstructure.

Glossary of terms

In this place, the following terms or expressions are used with the meaning indicated:

Polymer	a macromolecular substance (typically $M > 10000$ g/mol) comprising repeating units made up of one or several kinds of atoms or groups of atoms, which are identically connected to one another.
Oligomer	compound with more than two identical repeating units connected to one another and typically 500 less than M less than 10000 g/mol; grouped with the respective polymers

Synonyms and Keywords

In patent documents, the following abbreviations are often used:

PEG	poly ethyleneglycol
-----	---------------------

In patent documents, the following words/expressions are often used as synonyms:

- "Polyethylene glycol" or PEG, "polyethylene oxide" or PEO, "polyoxyethylene" or POE and the tradename "Carbowax"

B01J 31/12

containing organo-metallic compounds or metal hydrides

Definition statement

This place covers:

Monomeric and polymeric organometallic compounds, the metals, with the exception of arsenic and antimony, including those defined in the notes under the title of section [C](#), and furthermore include the metalloid element boron as "metal".

In the case of organometallic polymers the metalloid elements silicon, arsenic, antimony, selenium and tellurium are furthermore covered under the term "metal".

References

Limiting references

This place does not cover:

Organometallic monomeric compounds of antimony, arsenic	B01J 31/0234
Organic monomeric compounds of silicon, selenium, tellurium	B01J 31/0272
Dendrimers	B01J 31/064
Calixarenes and hetero-analogues, e.g. thiacalixarenes	B01J 31/066
Molecularly imprinted polymers	B01J 31/067
(Sulfonated) Ion-exchange resins	B01J 31/08 , B01J 31/10
Polymer-bound organometallic complexes	B01J 31/165
Coordination polymers	B01J 31/1691
Catalysts for the preparation of polysiloxanes, e.g. Karstedt catalysts	C08G 77/08

Informative references

Attention is drawn to the following places, which may be of interest for search:

Organometallic compounds per se	C07F
---------------------------------	----------------------

Special rules of classification

[B01J 31/123](#): if the organometallic polymer carries a coordination complex and that complex is covalently bound, it may be additionally classified in these groups, if appropriate (i.e. providing additional information). In any case it is to be classified in [B01J 31/1675](#).

[B01J 31/128](#): this subgroup is only used when at least two different species of organometallic compounds are involved, e.g. by addition of two different organometallic starting compounds.

Glossary of terms

In this place, the following terms or expressions are used with the meaning indicated:

Organometallic compounds	all organic compounds wherein a metal or metalloid atom is bonded directly to a carbon fragment, the latter being formally anionic, no further neutral ligands being coordinated to the metal and the compound requiring no further cations for charge balance; e.g. $M(CR_3)_n$ with M= main group metal, n= valency of metal and R= H or hydrocarbyl.
--------------------------	---

B01J 31/16**containing coordination complexes****Definition statement**

This place covers:

[B01J 31/16](#) - [B01J 31/2495](#): Catalysts containing coordination complexes with inorganic or organic ligands, including organometallic complexes on an inorganic or polymer support, coordination polymers and metal-organic frameworks, as well as phosphines.

References**Limiting references**

This place does not cover:

Compounds comprising only alkyl groups bonded to a metal	B01J 31/12
(Poly)Oxoacid (poly)salts	B01J 31/02 , B01J 31/10
Other compounds comprising only anionic organo-nitrogen, organo-oxygen or organo-sulfur fragments with a metal bonded to these heteroatoms, e.g. $Ti(OR)_4$	B01J 31/02 - B01J 31/0254

Informative references

Attention is drawn to the following places, which may be of interest for search:

Preparation of metal complexes, including MOFs, containing carboxylic acid moieties per se	C07C 51/418
MOF's per se	C07F , in particular C07F 19/005

Special rules of classification

Each coordinating atom and its respective environment is separately classified, viz. in terms of atoms or functional groups involved, unless provided for by way of specific multi-atom donor sets (e.g. [B01J 31/189](#), [B01J 31/2217](#), [B01J 31/2221](#), [B01J 31/2495](#)).

All complexes are further indexed in [B01J 2231/00](#) according to specifically disclosed intended use(s), unless already provided for otherwise (e.g. by way of complete classification in [C07C](#)) and in [B01J 2531/00](#) according to the central metals in the complexes and further structural aspects, such as number of donor atoms, geometry, chirality, metal bonding mode, polynuclearity, as well as chemical environment aspects, such as any special solvents being used or phase-transfer systems. If appropriate, further compositional aspects such as essential non-coordinating substituents on the ligands can be indexed in [B01J 2540/00](#).

[B01J 31/1616](#), [B01J 31/165](#): In these groups and their respective sub-groups [B01J 31/1625](#) - [B01J 31/1641](#) and [B01J 31/1658](#) - [B01J 31/1683](#), the coordination environment would be additionally classified as the corresponding complex wherein the solid support has been replaced by a hydrogen atom. The terms [B01J 2531/0205](#) - [B01J 2531/0222](#) would be likewise used to define the respective catalyst (component) further, by indexing according to the corresponding complex attached, e.g.:

mono- di- or oligomeric cobalt(salen) complex covalently bound via alkylene tether and -Si(Me)(OEt)₂ groups to silica (cf. WO2010/099300 A) => term is [B01J 2531/0216](#) since a bi- or polynuclear complex, without metal-carbon bonds, is involved (the two coordinating metals, Co(III), not shown

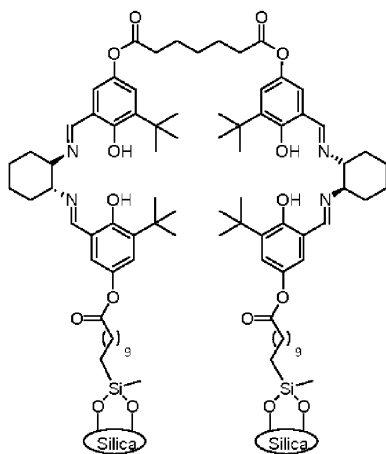

below):

copolymer of [2-Ph₂PCH₂-4-PPh₂-1-acryloyl-pyrrolidine]Pt(Cl)SnCl₃ and styrene (cf. WO 88/08835 A) => term is [B01J 2531/0219](#) since a bimetallic complex, without metal-carbon bonds, is involved.

If a support is involved, which is not already covered by these groups (e.g. because it is only broadly defined or because there is no adequately specific classification group for it), it would be additionally classified in groups [B01J 21/00](#), [B01J 23/00](#) or [B01J 29/00](#), respectively in the appropriate sub-groups of [B01J 31/061](#) - [B01J 31/068](#) or [B01J 31/124](#) - [B01J 31/127](#). Alternatively, if not essential to the invention, the support may also be so indexed with the corresponding groups [B01J 21/00](#), [B01J 23/00](#) or [B01J 29/00](#), respectively in the appropriate sub-groups of [B01J 31/061](#) - [B01J 31/068](#) or [B01J 31/124](#) - [B01J 31/127](#), see also the classification rules for [B01J 21/00](#) - [B01J 29/00](#) and [B01J 32/00](#) - [B01J 38/00](#).

[B01J 31/1691](#): In this group the principal ligands (e.g. dicarboxylate, bipyridine, pyrazine, dabco) would be classified with the appropriate groups from [B01J 31/16](#) and subgroups, e.g. [B01J 31/2239](#) for dicarboxylate linkers;

the orthogonal Indexing Code terms [B01J 2531/0205](#) - [B01J 2531/0222](#), would be used to define the respective catalyst (component) further according to the respective SBU comprising the metal, e.g.:

tetrahedral $[Zn_4O]$ in MOF-5 and the IRMOF series => term is [B01J 2531/0216](#) since a bi- or polynuclear complex, without metal-carbon bonds, is involved;

paddle-wheel $[Cu_2(O_2CR)_4]$, comprising a Cu-Cu bond, present in typical copper-based MOFs, e.g. $[Cu_2(1,4-bdc)_2](4,4'-bipy)$ => term is [B01J 2531/0219](#), since a bimetallic complex, without metal-carbon bonds, is involved.

[B01J 31/189](#): In this subgroup only those metal complex ligands are to be classified that:

are (at least) bidentate, i.e. two bonds from two different atoms to the central metal, typically as chelate (=> adjacent atoms, e.g. in $R_2P-NR'R''$ will not form a complex with both N and P coordinating for geometrical reasons (ring strain), as is also the case for e.g. phosphites, which are known to only coordinate via P, not via both P and O, hence at least a one-atom space is required between P and N):

- one of these atoms is N, e.g. as amine, imine, amide; and
- the other is P, e.g. as phosphite, phosphonite, phosphinite, phosphine;

are described as forming bidentate complexes/chelates or at least reasonably are expected to do so (criteria see above).

Typical example:

$R_2P-Cn-NR'_2$ ($n \geq 1$; R= hydrocarbyl, hydrocarbyloxy, -thio, etc.; R'= hydrocarbyl-C(=O)-, hydrocarbyl; rings possible using combinations of (R)s and/or (R')s).

Typical non-examples:

$R_2P-NR'-PR_2$ (with R, R' as above: as amide derivatives of phosphites, phosphonites or phosphinites, with no coordination by N yet known, these would respectively be [B01J 31/186](#), [B01J 31/187](#) or [B01J 31/188](#).);

$(RO)_2P-NR'_2$ (with R= hydrocarbyl, R' as above, ring possibilities as above: amide derivatives of phosphites, i.e. phosphoramidites, these would be [B01J 31/186](#)).

[B01J 31/24](#): In this group, phosphines are considered to be all compounds (ligands) that have phosphorus bonded to only carbon atoms, or to both carbon and hydrogen atoms, including sp^2 -hybridised phosphorus compounds such as phosphabenzene, phosphole (with a P-H bond) or anionic phospholide ligands (i.e. the P-deprotonation product of phosphole). Hence complexes with the parent PH_3 ligand would be classified in [B01J 31/1845](#).

Glossary of terms

In this place, the following terms or expressions are used with the meaning indicated:

Coordination complexes	all donor-acceptor compounds or complex ions comprising organic or inorganic, anionic or neutral Lewis basic ligands, attached to a Lewis acid central metal or metal ion through one or several complexing donor atoms with at least one lone-pair of electrons, e.g. N, O, S, P, to provide at least a sigma-bond; typically the maximum number of same or different ligands according to the coordination number, spatial requirements of the ligand and electronic configuration of the metal is bound in a predictable geometry; complexes of neutral, cationic or anionic hydrocarbon ligands with delocalised charge and/or bonding site, e.g. Pd-olefin complexes or metallocenes, are also included.
------------------------	---

Organometallic complexes	all coordination complexes comprising a M-C bond, e.g. metal carbonyls; included are furthermore complexes which are not strictly organometallic per se, e.g. comprising only N, O, S and/or P coordinated ligands, but are described as involving, or known to involve, organometallic intermediates and/or transition states during use, e.g. Group 8-10 metal complexes for a variety of catalytic reactions or steps thereof, such as oxidative addition, e.g. of ArX, hydrogenation, carbonylation, epoxidation.
Metal-organic framework	crystalline compounds consisting of metal ions or clusters coordinated to often rigid organic molecules as linkers to form one-, two-, or three-dimensional structures; see e.g. reviews: - O. Yaghi et al., Nature 423 (2003) 705-714 (XP2392829), - M.J. Rosseinsky, Micropor. Mesopor. Mat. 73 (2004) 15-30 (XP4522127); the linkers are often dicarboxylates, the metals often Zn, Cu, Fe or Al.
Chelating or multidentate ligands	a ligand having more than one donor (Lewis basic) centre, the centres not being on contiguous atoms and being lone electron pairs, with each of these centres connecting to a common metal centre; the prefix κ denotes these ligands, the superscript index quantifies the number of bonding atoms of the ligand involved (κ^2 : bidentate ligand, usually omitted if no other coordinating entities are present)

Synonyms and Keywords

In patent documents, the following abbreviations are often used:

MOF	metal-organic framework
Acac	acetylacetonate

B01J 31/22

Organic complexes

Definition statement

This place covers:

Catalysts comprising coordination complexes comprising organic ligands, including polynuclear carboxylate complexes such as "Pd(II)acetate", i.e. Pd₃(OAc)₆, "Pt(II)acetate", i.e. Pt₄(OAc)₈ or "Cr(II)acetate", i.e. Cr₂(OAc)₄.

References

Limiting references

This place does not cover:

Complexes of organic silicon ligands	B01J 31/1608
Organic coordination complexes immobilised on an inorganic support	B01J 31/1616
Organic coordination complexes immobilised on a polymer support	B01J 31/165
Coordination polymers, e.g. metal-organic frameworks (MOF)	B01J 31/1691

Complexes containing nitrogen, phosphorus, arsenic or antimony as complexing atoms in organic ligands, if no oxygen as additional complexing atom is present, as in the case of e.g. the phosphite / phosphonate tautomer pair	B01J 31/18
Complexes of organic phosphines	B01J 31/24

Informative references

Attention is drawn to the following places, which may be of interest for search:

Catalysts comprising metal carbonyls	B01J 31/20
--------------------------------------	----------------------------

Special rules of classification

[B01J 31/2265](#) (carbenes or carbynes): when more than one carbene ligand is involved and they differ from one another, this feature is separately classified in [B01J 31/2278](#), in addition to that regarding the structural type of carbene ligand, i.e. generic / heterocyclic carbene / NHC as classified in [B01J 31/2265](#), [B01J 31/2269](#) and [B01J 31/2273](#), respectively.

Additional classification should be given in groups [B01J 31/22](#) for those complexes referred out above if appropriate groups are found, e.g. for ligands of [B01J 31/22](#) attached to a polymer or inorganic support or included in a coordination polymer.

Example P----O ligand (---- being a carbon-containing bridge with a P-C bond) => [B01J 31/22](#)

but

Non-example phosphate => [B01J 31/1845](#)

Non-example PNP-ligands of general structure R₂P-N(R)-PR₂ =>

[B01J 31/188](#) (amide derivative of a phosphinite ligand)

Glossary of terms

In this place, the following terms or expressions are used with the meaning indicated:

Organic ligand	a carbon-containing ligand bonded to a central metal in which said carbon is bonded to - a second carbon;- at least one atom of hydrogen or halogen; or - nitrogen by a single or double bond; except cyanic acid (HO-C≡N), cyanogen (N≡C-C≡N), cyanamide (H ₂ N-C≡N), cyanogen halide (Hal-C≡N), hydrocyanic acid (HC≡N), isocyanic acid (HN=C=O), fulminic acid (HC≡N-O), carbides (C≡C) and the respective anionic ligands derived by deprotonation (O-C≡N, N=C=N, C≡N, N=C=O, C≡N-O).
Bridging ligand	a ligand connecting two or more metal centres in an at least binuclear complex, the metal atoms being directly bonded to another or not; the prefix μ denotes these ligands, the superscript index quantifies the number of metal centres connected (the simplest case, 2, may be omitted)
Chelating or multidentate ligands	a ligand having more than one donor (Lewis basic) centre, the centres not being on contiguous atoms and being lone electron pairs, with each of these centres connecting to a common metal centre; the prefix κ denotes these ligands, the superscript index quantifies the number of bonding atoms of the ligand involved (κ^2 : bidentate ligand, usually omitted if no other coordinating entities are present)

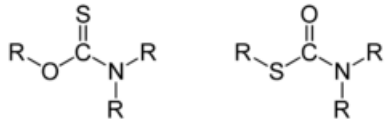
Polyhapto ligands	a ligand having a group of contiguous atoms, typ. a π -electron system, which are coordinated to a common central atom; the prefix η denotes these ligands, the superscript index quantifies the number of contiguous bonding atoms of the ligand involved (η^5 : pentahapto ligand, e.g. Cp)
Thiocarbamates	ligands of either one of the following isomeric structures: 
N-Heterocyclic carbene	a saturated or unsaturated heterocyclic compound comprising a neutral carbon atom with a lone electron pair (in the typical case of singlet or "nucleophilic" carbenes) adjacent to at least one nitrogen atom.

Synonyms and Keywords

In patent documents, the following abbreviations are often used:

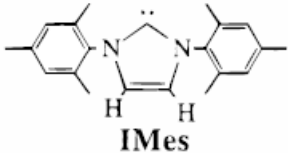
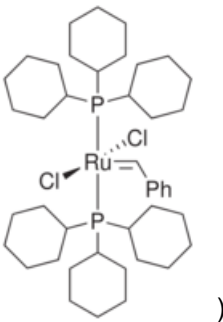
NHC	N-heterocyclic carbene
Cy	cyclohexyl
Mes	mesityl = 2,4,6-trimethylphenyl
IMes	 1,3-dimesitylimidazole-2-ylidene:
SIMes	1,3-dimesitylimidazolidine-2-ylidene (see below)
Grubbs catalyst, 1st generation or Grubbs-I	$X_2L_2Ru[=CHR]$; L= PR_3 , typ. PCy_3 (tricyclohexyl phosphine); X= anionic ligand, typ. Cl (e.g. Benzylidenebis(tricyclohexylphosphine)dichlororuthenium(II): 

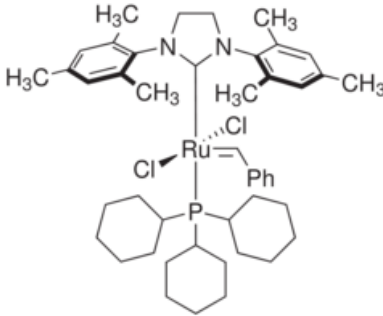
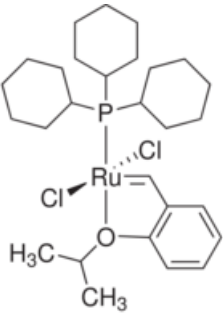
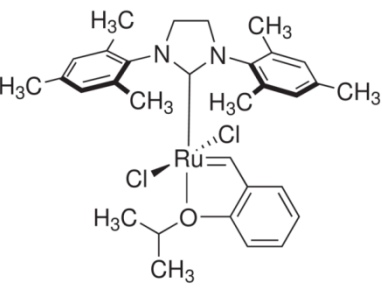
Grubbs catalyst, 2nd generation or Grubbs-II	<p>$X_2L^1L^2Ru[=CHR]$; $L^1 = PR_3$, typ. PCy_3; $L^2 = NHC$, typ. 1,3-dihydrocarbylimidazoline-2-ylidenes (e.g. IMes) or the corresponding imidazolidines (e.g. SIMes, see Fig); X as above (e.g. (1,3-Bis(2,4,6-trimethylphenyl)-2-imidazolidinylidene)dichloro(phenylmethylene)(tricyclohexylphosphine)ruthenium(II))</p> 
Hoveyda-Grubbs catalyst, 1st generation	<p>$X_2LRu=CHPhOiPr$; $L = PR_3$, typ. PCy_3; (e.g. Dichloro(o-isopropoxyphenylmethylene)(tricyclohexylphosphine)ruthenium(II):</p> 
Hoveyda-Grubbs catalyst, 2nd generation	<p>$X_2LRu=CHPhOiPr$; $L = NHC$, typ. SIMes (e.g. (1,3-Bis-(2,4,6-trimethylphenyl)-2-imidazolidinylidene)dichloro(o-isopropoxy phenylmethylene)ruthenium(II):</p> 
Cp	cyclopentadienyl
Cp*	pentamethyl cyclopentadienyl

B01J 31/26

containing in addition, inorganic metal compounds not provided for in groups [B01J 31/02](#) - [B01J 31/24](#)

Definition statement

This place covers:

Additionally added inorganic metal compounds, e.g. binary metal halides such as $TiCl_4$ or $FeCl_3$.

These subgroups [B01J 31/26](#) - [B01J 31/38](#) are only used if such inorganic additives do not give rise to in-situ formed coordination complexes (see also notes following main-group title [B01J 31/00](#)).

References

Limiting references

This place does not cover:

Catalysts comprising metal coordination complexes	B01J 31/16 - B01J 31/2495
---	---

Informative references

Attention is drawn to the following places, which may be of interest for search:

Catalysts comprising metal nanoparticles	B01J 21/00 - B01J 23/00 , B01J 35/0013 , B01J 35/006
Catalysts comprising the elements or inorganic compounds of carbon, halogens, sulfur, selenium, tellurium, phosphorus or nitrogen	B01J 27/00

Special rules of classification

If two components, even if separately added, are described as forming, or known to form, a coordination complex, only the latter is classified, e.g. phosphine and Group 8-10 metal such as rhodium. The groups [B01J 31/26](#) - [B01J 31/38](#) are not to be used for the central metals in coordination complexes. The specifically disclosed central metal(s) of said complexes are indexed in [B01J 2531/10](#) - [B01J 2531/847](#).

Glossary of terms

In this place, the following terms or expressions are used with the meaning indicated:

Inorganic compounds	compounds other than organic compounds
---------------------	--

B01J 31/40

Regeneration or reactivation

Definition statement

This place covers:

Regeneration or reactivation of the catalysts, catalyst systems or constituents thereof (e.g. metal, ligand) comprising hydrides, coordination complexes or organic compounds by chemical and/or physical means, e.g. membrane separation, extraction with special solvents, electrochemical processes.

Special rules of classification

These subgroups are only used if non-trivial regeneration or reactivation steps are at least disclosed, i.e. more than simple filtration and/or washing in the case of supported catalysts.

Regeneration processes may additionally be classified in [B01J 38/00](#), if pertinent details of the regeneration process are disclosed.

B01J 32/00**Catalyst carriers in general****Special rules of classification**

This main group is not used. Covered by [B01J 21/00](#) - [B01J 29/00](#)

B01J 33/00**Protection of catalysts, e.g. by coating****Definition statement**

This place covers:

Any protection of catalysts ; Conditioning catalyst such that it can be stored or transported, e.g. by coating with a removable material, by passivation involving controlled exposure to oxygen or by other generally reversible

B01J 35/00**Catalysts, in general, characterised by their form or physical properties****Definition statement**

This place covers:

Catalysts characterised by their form or physical properties, e.g. particle size, pore size, surface area

Special rules of classification

Multiple classification: All relevant groups of this main group are allocated.

Catalytic membrane is classified in [B01J 35/065](#)

B01J 35/0013**{Colloids}****Definition statement**

This place covers:

Nanoparticles

Special rules of classification

This class is assigned to catalysts comprising nanoparticles, even if not suspended in a liquid, i.e. even if strictly speaking no colloid.

If particle size indicated, [B01J 35/006](#) is additionally allocated

B01J 35/004**{Photocatalysts}****References****Limiting references**

This place does not cover:

Coating compositions per se	C09D 1/00 , C09D 5/00
-----------------------------	---

Informative references

Attention is drawn to the following places, which may be of interest for search:

FI	B01J 35/02
Disinfection, sterilisation or deodorisation of air using a photocatalyst or photosensitiser	A61L 9/205
Treatment of water with photocatalysts	C02F 1/725
Glass coated with TiO ₂	C03C 17/256
Coating compositions	C09D 1/00 , C09D 5/16

B01J 35/04**Foraminous structures, sieves, grids, honeycombs****Definition statement**

This place covers:

Ceramic foams etc.

References**Informative references**

Attention is drawn to the following places, which may be of interest for search:

Wall flow filters	B01D 46/00
Exhaust gas treating with catalysts	B01D 53/00
Honeycomb structures per se	C04B 38/0006
Mechanical aspects relating to exhaust gas treatment	F01N 3/00

B01J 35/10**characterised by their surface properties or porosity****References****Limiting references**

This place does not cover:

In this group, zeolites are not classified, if the application / patent merely describes the normal properties of the zeolite. Only if the surface properties or porosity have been changed substantially, [B01J 35/10](#) and subgroups are used for zeolites.

B01J 37/00

Processes, in general, for preparing catalysts; Processes, in general, for activation of catalysts

Definition statement

This place covers:

Processes for preparing any type of catalysts

References**Limiting references**

This place does not cover:

Electrocatalysts, electrodes	H01M
------------------------------	----------------------

Special rules of classification

Multiple classification: All relevant groups of this main group are allocated.

B01J 37/0018

{Addition of a binding agent or of material, later completely removed among others as result of heat treatment, leaching or washing,(e.g. forming of pores; protective layer, desintegrating by heat)}

Definition statement

This place covers:

Use of pore forming agents including mineral oils, steric acid, polyethylene glycol polymers, carbohydrate polymers, methacrylates, cellulose polymers, and carboxylates which decompose upon being heated.

Special rules of classification

When applicable, groups from [B01J 35/10](#) are to be given additionally

B01J 37/0211

{using a colloidal suspension}

Definition statement

This place covers:

reverse micelle

B01J 37/0215

{Coating}

References**Limiting references**

This place does not cover:

Devices for coating, coating in general	B05D
---	----------------------

Paints, coating compositions per se	C09D 1/00 , C09D 5/00
-------------------------------------	---

B01J 37/0228

{in several steps}

References**Limiting references***This place does not cover:*

Preparation of multilayered catalysts	B01J 37/0244
---------------------------------------	------------------------------

B01J 37/0238

{via the gaseous phase-sublimation}

Definition statement*This place covers:*

chemical vapor deposition (CVD)

References**Limiting references***This place does not cover:*

Physical vapor deposition	B01J 37/347
---------------------------	-----------------------------

Special rules of classificationadd KW 37 cvd general ([B01J](#))**B01J 37/0244**

{Coatings comprising several layers}

Definition statement*This place covers:*

catalysts having a multi-layer structure, such as some exhaust gas catalysts

References**Informative references***Attention is drawn to the following places, which may be of interest for search:*

Multilayered exhaust gas treating catalysts	B01D 2255/902
---	-------------------------------

B01J 37/06

Washing {([B01J 37/0009](#), [B01J 37/0018](#) take precedence)}

Definition statement

This place covers:

Also includes leaching or etching by acids or bases

Special rules of classification

[B01J 37/0009](#), [B01J 37/0018](#) take precedence

B01J 37/30

Ion-exchange

References**Limiting references**

This place does not cover:

ion exchange of zeolite (see [B01J 2229/18](#) and subgroups)

B01J 37/347

{Ionic or cathodic spraying; Electric discharge}

Definition statement

This place covers:

physical vapor deposition (PVD)

References**Informative references**

Attention is drawn to the following places, which may be of interest for search:

Physical vapor deposition in genera	C23C 14/00
-------------------------------------	----------------------------

Special rules of classification

add KW 37 pvd general ([B01J](#)) or 37 pvd sputtering ([B01J](#))

B01J 38/00

Regeneration or reactivation of catalysts, in general

Definition statement

This place covers:

Any processes, treatments to regenerate or reactivate catalysts in general, e.g. heat treatment, gas or vapour treatment, liquid treatment

References

Limiting references

This place does not cover:

Electrocatalysts, electrodes	H01M
------------------------------	----------------------

Special rules of classification

Multiple classification: All relevant groups of this main group are allocated.

The regeneration of a specific catalyst composition is classified also in [B01J 21/20](#), [B01J 23/90-B01J 23/96](#), [B01J 25/04](#), [B01J 27/28-B01J 27/32](#), [B01J 29/90](#) according to the catalyst composition.

[B01J 38/00](#) subgroups are used in combination with the specific groups mentioned above for detailed process.

Activation of new catalysts is classified in [B01J 37/00](#).

Re-activation of spent/used catalysts is classified in [B01J 38/00](#)

Glossary of terms

In this place, the following terms or expressions are used with the meaning indicated:

Reactivation= regeneration of catalyst	recovery of catalytic activity, rejuvenation, renewing a catalyst or making it reusable
--	---

B01J 38/48

Liquid treating or treating in liquid phase, e.g. dissolved or suspended

References

Limiting references

This place does not cover:

Recovery of metals from (spent) catalysts	C22B
---	----------------------

B01J 39/00

Cation exchange; Use of material as cation exchangers; Treatment of material for improving the cation exchange properties (ion-exchange chromatography processes [B01D 15/36](#))

Definition statement

This place covers:

- processes involving solid inorganic or organic cation exchangers and uses of inorganic or organic materials as cation exchangers whereby cations are exchanged between the solid exchanger and a medium to be treated.
- the treatment of inorganic or organic materials used as cation exchangers.
- cation exchangers as stationary phases or packings for chromatography processes.

Relationships with other classification places

In groups [B01J 39/00](#) - [B01J 49/00](#), in the absence of an indication to the contrary, classification is made in the last appropriate place.

Compositions, apparatus or processes involving at least two different types of ion exchangers, e.g. two different cation exchangers, or a cation exchanger and an anion exchanger, are classified using a combination of the corresponding classes.

For example:

- a process involving an organic cation exchanger in the strongly acidic form and an organic cation exchanger in the weakly acidic form is classified with [B01J 39/05](#) and [B01J 39/07](#).
- a process involving an inorganic cation exchanger and an inorganic anion exchanger is classified with [B01J 39/02](#) and [B01J 41/02](#).
- a process involving an organic cation exchanger in the strongly acidic form and an organic anion exchanger in the weakly basic form is classified with [B01J 39/05](#) and [B01J 41/07](#).

References

Limiting references

This place does not cover:

Preparative chromatography processes involving cation exchange	B01D 15/36
--	----------------------------

Informative references

Attention is drawn to the following places, which may be of interest for search:

Ion exchange resins used as catalyst	B01J 31/08
Processes in general for preparing or activating catalysts using ion exchange	B01J 37/30
Regeneration or reactivation of catalysts using ion-exchange	B01J 38/74
Regeneration or reactivation of cation exchangers	B01J 49/00-B01J 49/90
Modifying dairy products by ion exchange	A23C 9/146
Clarifying, fining of non-alcoholic beverage by ion-exchange	A23L 2/78
Removal of unwanted matter from foods or foodstuffs using ion exchangers	A23L 5/273
Use of ion exchange materials for tobacco smoke filters	A24D 3/12
Separation of different isotopes of the same chemical element by ion exchange	B01D 59/30
Processes involving the treatment of (waste) water by ion-exchange	C02F 1/42 , C02F 2001/422 , C02F 2001/425 , C02F 2001/427
Purification or separation of hydrocarbons with ion-exchangers	C07C 7/12
Extraction, separation or purification of peptides by ion exchange chromatography	C07K 1/18
Manufacture of shaped structures of ion-exchange resins	C08J 5/20
Refining of hydrocarbon oils by ion-exchange material	C10G 25/02
Purification, clarification of alcoholic beverages with the aid of ion-exchange material	C12H 1/04

Extracting or separating nucleic acids from biological samples by ion-exchange chromatography	C12N 15/101
Purification of sugar juices using ion exchange materials	C13B 20/14
Extraction of sugar from molasses using ion exchange	C13B 35/06
Treatment or purification by ion exchange of solutions obtained from the extraction of metals from ores	C22B 3/42
Investigative or analytical chromatography processes involving cation exchange	G01N 30/96
Treating radioactively contaminated liquids using ion exchange	G21F 9/12

B01J 41/00

Anion exchange; Use of material as anion exchangers; Treatment of material for improving the anion exchange properties (ion-exchange chromatography processes [B01D 15/36](#))

Definition statement

This place covers:

- Processes involving solid inorganic or organic anion exchangers and uses of solid inorganic or organic materials as anion exchangers whereby anions are exchanged between the solid exchanger and a medium to be treated.
- the treatment of inorganic or organic materials used as anion exchangers.
- anion exchangers as stationary phases or packing for chromatography processes.

Relationships with other classification places

In groups [B01J 39/00](#) - [B01J 49/00](#), in the absence of an indication to the contrary, classification is made in the last appropriate place.

Compositions, apparatus or processes involving at least two different types of ion exchangers, e.g. two different anion exchangers, or a cation exchanger and an anion exchanger, are classified using a combination of the corresponding classes

For example:

- a process involving an organic anion exchanger in the strongly basic form and an organic anion exchanger in the weakly basic form is classified with [B01J 41/05](#) and [B01J 41/07](#).
- a process involving an inorganic cation exchanger and an inorganic anion exchanger is classified with [B01J 39/02](#) and [B01J 41/02](#).
- a process involving an organic cation exchanger in the strongly acidic form and an organic anion exchanger in the weakly basic form is classified with [B01J 39/05](#) and [B01J 41/07](#).

References

Limiting references

This place does not cover:

Preparative chromatography processes involving anion exchange	B01D 15/36
---	----------------------------

Informative references

Attention is drawn to the following places, which may be of interest for search:

Ion exchange resins used as catalyst	B01J 31/08
--------------------------------------	----------------------------

Processes in general for preparing or activating catalysts using ion exchange	B01J 37/30
Regeneration or reactivation of catalysts using ion-exchange	B01J 38/74
Regeneration or reactivation of anion exchangers	B01J 49/00-B01J 49/90
Modifying dairy products by ion exchange	A23C 9/146
Clarifying, fining of non-alcoholic beverage by ion-exchange	A23L 2/78
Removal of unwanted matter from foods or foodstuffs using ion exchangers	A23L 5/273
Use of ion exchange materials for tobacco smoke filters	A24D 3/12
Separation of different isotopes of the same chemical element by ion exchange	B01D 59/30
Processes involving the treatment of (waste) water by ion-exchange	C02F 1/42 , C02F 2001/422 , C02F 2001/425 , C02F 2001/427
Purification or separation of hydrocarbons with ion-exchangers	C07C 7/12
Extraction, separation or purification of peptides by ion exchange chromatography	C07K 1/18
Manufacture of shaped structures of ion-exchange resins	C08J 5/20
Refining of hydrocarbon oils by ion-exchange material	C10G 25/02
Purification, clarification of alcoholic beverages with the aid of ion-exchange material	C12H 1/04
Extracting or separating nucleic acids from biological samples by ion-exchange chromatography	C12N 15/101
Purification of sugar juices using ion exchange materials	C13B 20/14
Extraction of sugar from molasses using ion exchange	C13B 35/06
Treatment or purification by ion exchange of solutions obtained from the extraction of metals from ores	C22B 3/42
Investigative or analytical chromatography processes involving anion exchange	G01N 30/96
Treating radioactively contaminated liquids using ion exchange	G21F 9/12

B01J 41/10

Inorganic material

References

Informative references

Attention is drawn to the following places, which may be of interest for search:

Carbon, coal or tar	B01J 41/18
---------------------	----------------------------

B01J 43/00

Amphoteric ion-exchange, i.e. using ion-exchangers having cationic and anionic groups; Use of material as amphoteric ion-exchangers; Treatment of material for improving their amphoteric ion-exchange properties (ion-exchange chromatography processes [B01D 15/36](#))

Definition statement

This place covers:

- processes involving solid amphoteric ion exchanger materials, i.e. having cation exchanging and anion exchanging groups and uses of such materials whereby both cations and anions are exchanged between the solid exchanger and a medium to be treated.
- the treatment of these materials used as amphoteric ion-exchangers.
- amphoteric ion exchange materials as stationary phase or packing for chromatography processes.

References**Limiting references**

This place does not cover:

Regeneration or reactivation of ion exchangers	B01J 49/00- B01J 49/90
Preparative chromatography processes involving ion exchange	B01D 15/361
Investigative or analytical chromatography processes involving ion exchange	G01N 30/96

Informative references

Attention is drawn to the following places, which may be of interest for search:

Ion exchange relating to particular applications, or relating to treating particular compound, may be classified in the following non-exhaustive list:

Ion exchange resins used as catalyst	B01J 31/08
Processes in general for preparing or activating catalysts using ion exchange	B01J 37/30
Regeneration or reactivation of catalysts using ion-exchange	B01J 38/74
Modifying dairy products by ion exchange	A23C 9/146
Clarifying, fining of non-alcoholic beverage by ion-exchange	A23L 2/78
Removal of unwanted matter from foods or foodstuffs using ion exchangers	A23L 5/273
Use of ion exchange materials for tobacco smoke filters	A24D 3/12
Separation of different isotopes of the same chemical element by ion exchange	B01D 59/30
Processes involving the treatment of (waste) water by ion-exchange	C02F 1/42 and Indexing Code C02F 1/42 , C02F 2001/422 , C02F 2001/425 , C02F 2001/427
Purification or separation of hydrocarbons with ion-exchangers	C07C 7/12

Extraction, separation or purification of peptides by ion exchange chromatography	C07K 1/18
Manufacture of shaped structures of ion-exchange resins	C08J 5/20
Refining of hydrocarbon oils by ion-exchange material	C10G 25/02
Purification, clarification of alcoholic beverages with the aid of ion-exchange material	C12H 1/04
Extracting or separating nucleic acids from biological samples by ion-exchange chromatography	C12N 15/101
Purification of sugar juices using ion exchange materials	C13B 20/14
Extraction of sugar from molasses using ion exchange	C13B 35/06
Treatment or purification by ion exchange of solutions obtained from the extraction of metals from ores	C22B 3/42
Treating radioactively contaminated liquids using ion exchange	G21F 9/12

Special rules of classification

In groups [B01J 39/00](#) - [B01J 49/00](#), in the absence of an indication to the contrary, classification is made in the last appropriate place.

B01J 45/00

Ion-exchange in which a complex or a chelate is formed; Use of material as complex or chelate forming ion-exchangers; Treatment of material for improving the complex or chelate forming ion-exchange properties (ion-exchange chromatography processes [B01D 15/36](#))

Definition statement

This place covers:

- Processes involving solid inorganic or organic ion exchangers and use of inorganic or organic materials as ion exchangers whereby the ion exchangers forms complexes or chelates and bring about ion exchange between the solid exchanger and a medium to be treated.
- the treatment of inorganic or organic materials used as ion exchanger in which a complex or chelate is formed.
- Ion exchange materials in which a complex or chelate is formed, the materials being used as stationary phases or packing for chromatography processes.

References

Limiting references

This place does not cover:

Regeneration or reactivation of ion exchangers	B01J 49/00 - B01J 49/90
Preparative chromatography processes or apparatus therefor involving ion exchange	B01D 15/361
Investigative or analytical chromatography processes or apparatus therefor involving ion exchange	G01N 30/96

Informative references

Attention is drawn to the following places, which may be of interest for search:

Ion exchange relating to particular applications, or relating to treating particular compound, may be classified in the following non-exhaustive list:

Ion exchange resins used as catalyst	B01J 31/08
Processes in general for preparing or activating catalysts using ion exchange	B01J 37/30
Regeneration or reactivation of catalysts using ion-exchange	B01J 38/74
Modifying dairy products by ion exchange	A23C 9/146
Clarifying, fining of non-alcoholic beverage by ion-exchange	A23L 2/78
Removal of unwanted matter from foods or foodstuffs using ion exchangers	A23L 5/273
Use of ion exchange materials for tobacco smoke filters	A24D 3/12
Separation of different isotopes of the same chemical element by ion exchange	B01D 59/30
Processes involving the treatment of (waste) water by ion-exchange	C02F 1/42 and Indexing Code C02F 1/42 , C02F 2001/422 , C02F 2001/425 , C02F 2001/427
Purification or separation of hydrocarbons with ion-exchangers	C07C 7/12
Extraction, separation or purification of peptides by ion exchange chromatography	C07K 1/18
Manufacture of shaped structures of ion-exchange resins	C08J 5/20
Refining of hydrocarbon oils by ion-exchange material	C10G 25/02
Purification, clarification of alcoholic beverages with the aid of ion-exchange material	C12H 1/04
Extracting or separating nucleic acids from biological samples by ion-exchange chromatography	C12N 15/101
Purification of sugar juices using ion exchange materials	C13B 20/14
Extraction of sugar from molasses using ion exchange	C13B 35/06
Treatment or purification by ion exchange of solutions obtained from the extraction of metals from ores	C22B 3/42
Treating radioactively contaminated liquids using ion exchange	G21F 9/12

Special rules of classification

In groups [B01J 39/00](#) - [B01J 49/00](#), in the absence of an indication to the contrary, classification is made in the last appropriate place.

B01J 47/00

Ion-exchange processes in general; Apparatus therefor (ion-exchange chromatography processes or apparatus [B01D 15/08](#))

Definition statement

This place covers:

Processes in general involving ion-exchange and apparatus therefor, comprising cationic, anionic or amphoteric ion exchange resin.

Relationships with other classification places

In groups [B01J 39/00](#) - [B01J 49/00](#), in the absence of an indication to the contrary, classification is made in the last appropriate place.

References

Limiting references

This place does not cover:

Ion-exchange chromatography processes or apparatus	B01D 15/08
--	----------------------------

Informative references

Attention is drawn to the following places, which may be of interest for search:

Ion exchange resins used as catalyst	B01J 31/08
Processes in general for preparing or activating catalysts using ion exchange	B01J 37/30
Regeneration or reactivation of catalysts using ion-exchange	B01J 38/74
Regeneration or reactivation of ion exchangers	B01J 49/00-B01J 49/90
Modifying dairy products by ion exchange	A23C 9/146
Clarifying, fining of non-alcoholic beverage by ion-exchange	A23L 2/78
Removal of unwanted matter from foods or foodstuffs using ion exchangers	A23L 5/273
Use of ion exchange materials for tobacco smoke filters	A24D 3/12
Arrangements or adaptation of water softeners and constructional details of the salt container or the ion exchanger in washing or rinsing machines for crockery or tableware	A47L 15/4229
Separation of different isotopes of the same chemical element by ion exchange	B01D 59/30
Processes or apparatus using semi-permeable membranes for electrolysis or electro-osmosis; Such processes or apparatus comprising ion exchange materials	B01D 61/42
Processes involving the treatment of (waste) water by ion-exchange	C02F 1/42 , C02F 2001/422 , C02F 2001/425 , C02F 2001/427
Treatment of water by electrodialysis, electrodeionisation, electro-osmosis, capacitive deionisation	C02F 1/469
Purification or separation of hydrocarbons with ion-exchangers	C07C 7/12

Extraction, separation or purification of peptides by ion exchange chromatography	C07K 1/18
Manufacture of shaped structures of ion-exchange resins	C08J 5/20
Refining of hydrocarbon oils by ion-exchange material	C10G 25/02
Purification, clarification of alcoholic beverages with the aid of ion-exchange material	C12H 1/04
Extracting or separating nucleic acids from biological samples by ion-exchange chromatography	C12N 15/101
Purification of sugar juices using ion exchange materials	C13B 20/14
Extraction of sugar from molasses using ion exchange	C13B 35/06
Treatment or purification by ion exchange of solutions obtained from the extraction of metals from ores	C22B 3/42
Arrangements of water softeners in washing machines	D06F 39/007
Investigative or analytical chromatography processes involving ion exchange	G01N 30/96
Treating radioactively contaminated liquids using ion exchange	G21F 9/12

B01J 49/00

Regeneration or reactivation of ion-exchangers; Apparatus therefor (ion-exchange chromatography processes or apparatus [B01D 15/08](#))

Definition statement

This place covers:

- Processes or apparatus for regeneration or reactivation of ion-exchangers.
- Reagents for regenerating or reactivating ion exchangers.
- Cleaning or rinsing of ion exchanger beds.

Relationships with other classification places

In groups [B01J 39/00](#) -[B01J 49/00](#), in the absence of an indication to the contrary, classification is made in the last appropriate place.

References

Limiting references

This place does not cover:

Ion-exchange chromatography processes or apparatus	B01D 15/08
--	----------------------------

Informative references

Attention is drawn to the following places, which may be of interest for search:

Regeneration or reactivation of solid sorbents ...	B01J 20/34
Arrangements or adaptation of water softeners and constructional details of the salt container or the ion exchanger in washing or rinsing machines for crockery or tableware	A47L 15/4229

Processes involving the treatment of (waste) water by ion-exchange	C02F 1/42 , C02F 2001/422 , C02F 2001/425 , C02F 2001/427
Arrangements of water softeners in washing machines	D06F 39/007

B01J 2219/00274

Sequential or parallel reactions; Apparatus and devices for combinatorial chemistry or for making arrays; Chemical library technology

Definition statement

This place covers:

This is an indexing scheme, where disclosed aspects of documents of relevance to [B01J 19/0046](#) are classified, irrespective of whether this is invention information or additional information. As this is a(n) (deep) indexing scheme, documents usually receive multiple codes under [B01J 2219/00274](#).

Documents may also receive codes under [B01J 2219/00274](#) despite not having been classified in [B01J 19/0046](#) if aspects are relevant to library technology.

Relationships with other classification places

Combinatorial libraries as such, and many aspects of combinatorial libraries, including synthesis, screening and identification of library members, relating to methods as well as devices, are not covered by this sub-group, but classified in [C07](#), [C12N](#), [C40B](#).

Microfluidic analysis and PCR devices are classified in [B01L 3/00](#).

Sampling and analysis devices per se are classified in [G01N](#).

References

Limiting references

This place does not cover:

Peptide libraries	C07K 1/047
Nucleic acid libraries and their screening	C12N 15/1034 and lower sub-groups
Nucleic acid analysis characterised by the use of probe arrays or probe chips.	C12Q 1/6837
Methods for sequencing involving nucleic acid arrays, e.g. Sequencing By Hybridisation	C12Q 1/6874
Combinatorial libraries as such	C40B 40/00 and lower sub-groups

Application-oriented references

Examples of places where the subject matter of this place is covered when specially adapted, used for a particular purpose, or incorporated in a larger system:

Immunoassays; Biospecific binding assay s.(on solid supports)	G01N 33/53 and lower sub-groups (G01N53/543 and subgroups)
---	--

Informative references

Attention is drawn to the following places, which may be of interest for search:

Compounds containing polynucleotide units obtained by (or as intermediates for) chemical engineering	C07H 21/00
Preparation of peptides on supports	C07K 1/04

Special rules of classification

This is an indexing scheme where the last-place Rule is not applied, but rather codes are given for every relevant aspect in a document. This is furthermore done regardless of whether this aspect appears in the claims, description or drawings.

Documents may receive codes under [B01J 2219/00274](#) despite not having been classified in [B01J 19/0046](#).

[B01J 2219/00286](#): Reactor vessels with top and bottom openings.

This code is used for flow-through reactors in general, even if openings are, for example, at the side rather than top and bottom.

[B01J 2219/00387](#): Applications using probes.

This code is also used for the use of pin-tools and dip-pen (nano-) lithography.

[B01J 2219/00738](#): Organic catalysts.

This code also includes organometallic catalysts, which are then not given the code [B01J 2219/00747](#).

Synonyms and Keywords

In patent documents, the following abbreviations are often used:

DPN	Dip Pen Nanolithography
-----	-------------------------

In patent documents, the following words/expressions are often used as synonyms:

- "stamping", "microcontact printing" and "soft lithography"

B01J 2231/00

Catalytic reactions performed with catalysts classified in [B01J 31/00](#)

Definition statement

This place covers:

The group [B01J 2231/00](#) is an indexing scheme, where specific catalytic reaction types of catalysts classified in [B01J 31/00](#) are indexed according to purpose or concept. Elements from in particular [C07B](#), [C07C](#), [C07D](#), [C08F](#) and [C08G](#) are incorporated. Multiple catalytic purposes are multiply indexed.

Polymerisation reactions are only indexed in groups [B01J 2231/10](#) - [B01J 2231/14](#) if at least a dual use of the catalyst is disclosed in the application, e.g. oligomerisation and polymerisation.

Relevant NPL publications such as review articles relating to methods of using catalyst systems are also indexed in this scheme.

References

Limiting references

This place does not cover:

catalysts used only in polymerisation reactions	C08 , M08
---	----------------------------------

Informative references

Attention is drawn to the following places, which may be of interest for search:

asymmetric syntheses in general	C07B 53/00
optical isomers in general	C07B 2200/07

Special rules of classification

In this group indexing is done according to the specific catalytic reaction. In case of multiple catalytic activities only those are indexed which are specifically exemplified, i.e. by ways of worked examples, specific claims or explicit alternatives therein.

General concepts, e.g. as presented in review articles, relating to methods of using catalyst systems are indexed in [B01J 2231/005](#), the concept being defined by a common method or theory, e.g. microwave heating or multiple stereoselectivity

Polymerisation reactions are only indexed in groups [B01J 2231/10](#) - [B01J 2231/14](#) if at least a dual use of the catalyst is disclosed in the application, e.g. oligomerisation and polymerisation.

Group [B01J 2231/76](#) includes dehydrogenative coupling, e.g. $2 \text{CH}_2=\text{CH}-\text{CH}_3 + \text{O}_2 + 2 \text{AcOH} \rightarrow 2 \text{CH}_2=\text{CH}-\text{CH}_2-\text{OAc} + 2 \text{H}_2\text{O}$; or $\text{H}_2\text{C}=\text{CH}_2 + \text{O}_2 + \text{AcOH} \rightarrow \text{H}_2\text{C}(\text{vinyl acetate})$;

incl. H abstraction by oxidant and radical recombination, e.g. cyclohexene + tBuOOC(=O)Ph \rightarrow cyclohexen-3-yl-OC(=O)Ph + tBuOH

B01J 2531/00

Additional information regarding catalytic systems classified in [B01J 31/00](#)

Definition statement

This place covers:

In this indexing scheme additional compositional aspects of the coordination complexes contained within group [B01J 31/00](#) are indexed, e.g. polynuclearity, ligand type, metal bonding mode(s) and the specifically disclosed central metal(s) therein.

Furthermore additional information is indexed regarding any special solvent (systems) used for any catalyst system of the group [B01J 31/00](#).

General concepts, e.g. as presented in review articles, relating to catalyst systems and methods of making them, the concept being defined by a common material or method/theory are indexed in [B01J 2531/001](#) - [B01J 2531/008](#).

Indexing codes [B01J 2531/0202](#) - [B01J 2531/0222](#) specify the presence and type of polynuclearity, as well as linkage type of the metals involved among themselves.

Indexing codes [B01J 2531/0225](#) - [B01J 2531/0283](#) characterise the complexes on the basis of bond-type (linkage-type) between central metal(s), thereby specifying the structural geometry of the complexes, while classification entries [B01J 31/16](#) - [B01J 31/24](#) are purely compositional subdivisions.

Indexing codes [B01J 2531/0286](#) - [B01J 2531/0297](#) broadly characterise ligands by their function.

Indexing codes [B01J 2531/10](#) - [B01J 2531/847](#) are used to index the individual (central) metals in the (polynuclear) complexes.

Special solvent (systems) used with any catalyst system of the group [B01J 31/00](#) are indexed in [B01J 2531/90](#) - [B01J 2531/985](#).

Special rules of classification

In this group the term "metals" refers to the central metal in the coordination complexes ([B01J 31/16](#) - [B01J 31/24](#)), as used for the respective catalytic reaction, excluding simple carboxylates (see [B01J 31/04](#)) and other simple salts or organometallic compounds (see [B01J 31/12](#)).

As to components, only those metals or solvents are indexed which are explicitly mentioned in the claims or the worked examples.

As to compositional aspects, only those are provided for in the scheme below and are intended to be indexed, which provide additional information regarding the complexes and/or ligands classified in [B01J 31/16](#) - [B01J 31/24](#). Indexing codes [B01J 2531/0286](#) - [B01J 2531/0297](#) are only used if these aspects are described as essential.

The individual metals, the compositional aspects of complexes used and the solvents are indexed for each explicit alternative, according to the guideline above.

As to concepts, only the focus is indexed in [B01J 2531/004](#) - [B01J 2531/007](#) and only if groups with closely related members are concerned, e.g. N-heterocyclic carbenes ([B01J 2531/004](#)), Pd-complexes ([B01J 2531/005](#)), added halide ([B01J 2531/007](#)). Otherwise the main code [B01J 2531/002](#) is used.

Glossary of terms

In this place, the following terms or expressions are used with the meaning indicated:

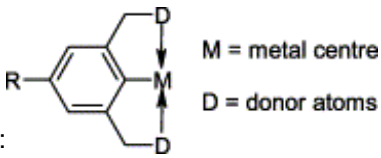
Ionic liquid	an organic salt in the liquid state at the reaction temperature employed, e.g. ≤ 100 °C or ≤ 20 °C ("room-temperature ionic liquid")
Bi- or polynuclear complex	a coordination complex comprising two or more same or different metal atoms, without M-M bonds; e.g. Cp(Lx)Zr-imidazole-Zr(Lx)Cp, $[R_2PCp-Fe-CpPR_2]Rh(L)_n$, [(salen)Co(III)]SbF ₆ , Co(II)(salen)Fe(II)Cl ₂ .
Bimetallic complex	a discrete coord. complex comprising one or more units of two metals, same or different, with metal-metal bonds but no all-metal (M) _n rings, e.g. Cr ₂ (OAc) ₄ , [(Mo ₂) ₄ (MeOPhNCNPhOMe) ₈ (Ph(COO) ₂) ₄], [Ph ₂ P-X-PPh ₂]Pt(Cl)SnCl ₃ , [Cp(CO) ₂ Mn=] ₂ Pb.
Metal cluster	a coordination complex with 3 to abt. 1000 same or different metal atoms and further comprising M-M bonds to provide (M) _n rings, i.e. size range from atomic to colloid dimensions; e.g. Rh _x (CO) _y , [R ₃ P=N=PR ₃] ⁺ [Ru ³ Ir(CO) ₁₃] ⁻ , [Rh ₃ (DIPAMP) ₃ (μ ₃ -OMe) ₂]BF ₄ , Pt ₄ (OAc) ₈ , "Pd(OAc) ₂ " = Pd ₃ (OAc) ₆ .
Pincer-type complexes	 <p>Example (with metal-carbon bond):</p>

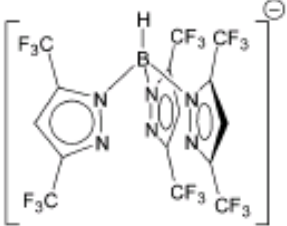
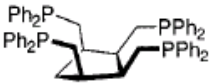
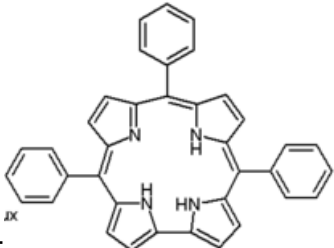
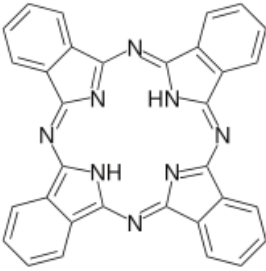
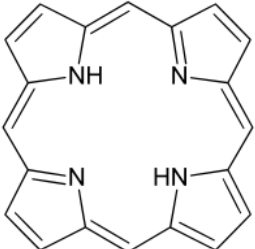
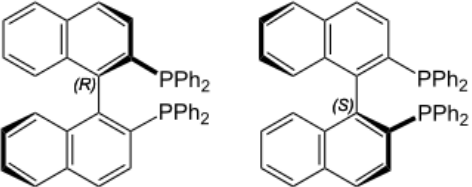
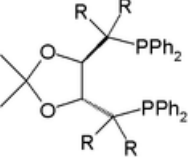
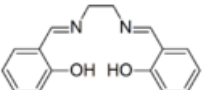
Tripodal ligand	<p>Example (tris(pyrazolyl)borate skeleton):</p> 
Tedicyp ligand (flexible)	
Corrole	 <p>Example:</p>
Phthalocyanin (parent structure)	
Porphyrin ring system	 <p>Example:</p>
BINAP (Ligand with axial chirality)	
DIOP (tartrate-derived ligand, example)	
Salen-ligand (parent structure)	

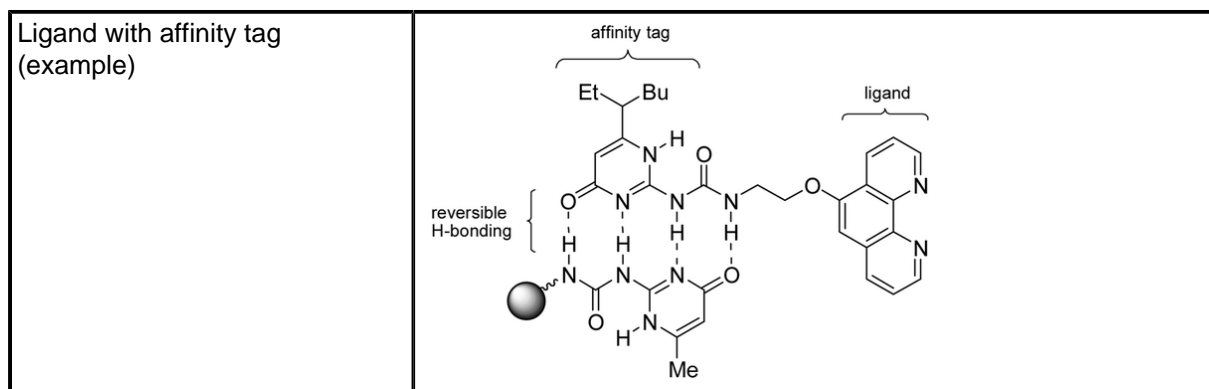

Synonyms and Keywords

In patent documents, the following abbreviations are often used:

(RT)IL	(room-temperature) ionic liquid
Cp	cyclopentadienyl
Cp*	pentamethyl cyclopentadienyl

B01J 2540/00

Compositional aspects of coordination complexes or ligands in catalyst systems

Definition statement

This place covers:

Additional information regarding catalytic systems classified in [B01J 31/00](#) and not covered by [B01J 2531/00](#).

In this group further compositional aspects of coordination complexes and/or ligands classified in [B01J 31/16](#) - [B01J 31/24](#) are indexed. Only such aspects are provided for and are intended to be indexed, which provide additional information regarding the complexes and/or ligands classified in [B01J 31/16](#) - [B01J 31/24](#) and indexed in [B01J 2531/00](#), e.g. non-coordinating substituents on the ligand described as essential, and which are explicitly mentioned in the claims or the worked examples.

The primary subdivision is according to heteroatoms in such substituents, cf. indexing codes [B01J 2540/10](#) (oxygen), [B01J 2540/20](#) (halogen), [B01J 2540/30](#) (sulfur), [B01J 2540/40](#) (nitrogen), [B01J 2540/50](#) (phosphorus). The respective lower groups define these heteroatom groups further.

A further primary subdivision is according to generic statements of function of substituent groups on the ligand, cf. [B01J 2540/60](#). These functions must be presented as essential in the application, either in the description or the claims. The focus here is more on the groups as such, whereas the codes in [B01J 2531/00](#), e.g. [B01J 2531/028](#) or [B01J 2531/0291](#) are used for the overall ligand. In case of doubt the codes of [B01J 2531/00](#) should be used.