

B21K

MAKING FORGED OR PRESSED METAL PRODUCTS, e.g. HORSE-SHOES, RIVETS, BOLTS OR WHEELS (making particular articles by working sheet metal without essentially removing material [B21D](#); processing wire [B21F](#); making pins, needles or nails [B21G](#); making particular articles by rolling [B21H](#); forging machines, pressing machines, hammering machines, in general [B21J](#); making chains [B21L](#); plating [B23K](#))

Definition statement

This place covers:

Metal forging or pressing methods dedicated to the manufacture of specific products; Devices for handling, heating or cooling, controlling forging hammers or presses.

Relationships with other classification places

This subclass subdivides into:

Metal forging or pressing methods dedicated to the manufacture of specific products: [B21K 1/00-B21K 25/005](#).

Devices for handling, heating or cooling, controlling forging hammers or presses: [B21K 27/00-B21K 31/00](#).

References

Limiting references

This place does not cover:

Making pressed products by rolling	B21B
Making pressed products from metal sheet, without substantially modifying the metal sheet thickness	B21D
Processing wire by forging	B21F
Making pins, needles or nails by forging	B21G
Making particular pressed products by rolling	B21H
Making chains by forging	B21L

Informative references

Attention is drawn to the following places, which may be of interest for search:

General metal forging or pressing methods not dedicated to the manufacture of a specific product; Metal forging or pressing devices and furnaces	B21J
Products per se obtainable by forging, e.g. pistons, rocking arms, etc.	F02F 3/00 , F01L 1/18

B21K 1/00**Making machine elements****Definition statement**

This place covers:

Metal forging or pressing methods dedicated to the manufacture of machine elements.

B21K 1/02**balls, rolls, or rollers, e.g. for bearings****Definition statement**

This place covers:

Metal forging or pressing methods dedicated to the manufacture of balls, rolls or rollers, e.g. for bearings.

Illustrative examples of subject matter classified in this group:

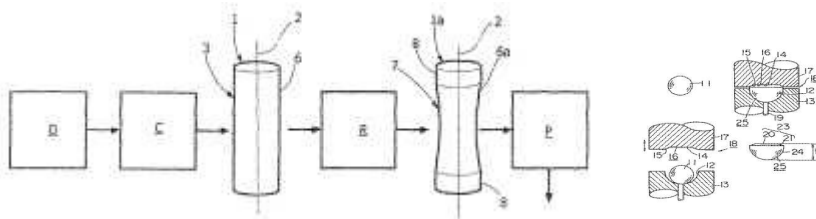
**B21K 1/025****{of bullets}****Definition statement**

This place covers:

Metal forging or pressing methods dedicated to the manufacture of bullets.

Illustrative examples of subject matter classified in this group:

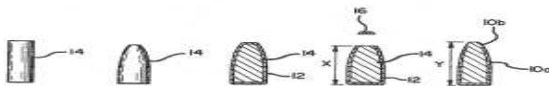
**B21K 1/04****ball-races {or sliding bearing races}****Definition statement**

This place covers:

Metal forging or pressing methods dedicated to the manufacture of ball races.

Illustrative examples of subject matter classified in this group:



References

Informative references

Attention is drawn to the following places, which may be of interest for search:

Parts of bearings	F16C 33/00
-------------------	----------------------------

B21K 1/05

cages for bearings

Definition statement

This place covers:

Metal forging or pressing methods dedicated to the manufacture of cages for bearings.

Illustrative examples of subject matter classified in this group:

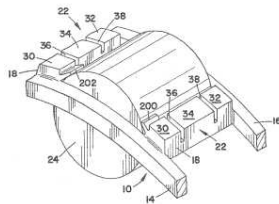

References

Informative references

Attention is drawn to the following places, which may be of interest for search:

Parts of bearings	F16C 33/00
-------------------	----------------------------

B21K 1/06

axles or shafts

Definition statement

This place covers:

Metal forging or pressing methods dedicated to the manufacture of axles or shafts.

References

Informative references

Attention is drawn to the following places, which may be of interest for search:

Axle units	B60B 35/00
------------	----------------------------

Shafts	F16C 3/00
--------	---------------------------

B21K 1/08

crankshafts

Definition statement

This place covers:

Metal forging or pressing methods dedicated to the manufacture of crankshafts.

Illustrative examples of subject matter classified in this group:

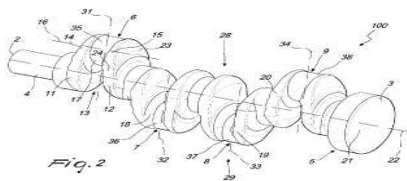

References

Informative references

Attention is drawn to the following places, which may be of interest for search:

Camshafts	F01L 1/047
Crankshafts	F16C 3/06

B21K 1/10

of cylindrical form

Definition statement

This place covers:

Metal forging or pressing methods dedicated to the manufacture of axles or shafts of cylindrical form.

Illustrative examples of subject matter classified in this group:

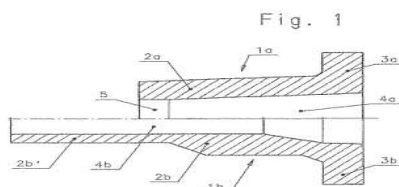

References

Informative references

Attention is drawn to the following places, which may be of interest for search:

Axle units	B60B 35/00
------------	----------------------------

B21K 1/12

of specially-shaped cross-section

Definition statement

This place covers:

Metal forging or pressing methods dedicated to the manufacture of axles or shafts of special cross-section.

Illustrative examples of subject matter classified in this group:

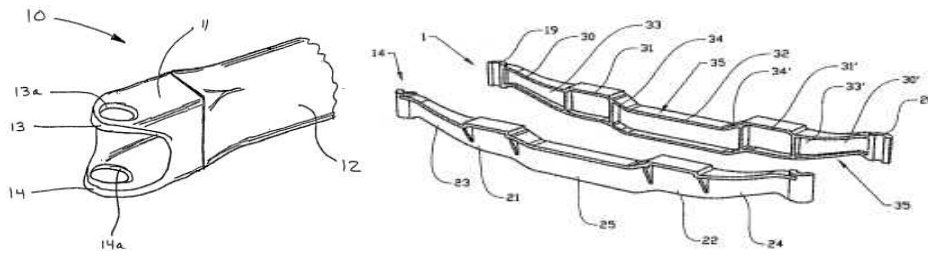

References

Limiting references

This place does not cover:

Shaping axles or shafts of special cross-section by applying fluid pressure	B21D 26/00
---	----------------------------

Informative references

Attention is drawn to the following places, which may be of interest for search:

Axle units	B60B 35/00
Shafts	F16C 3/00

B21K 1/14

fittings

Definition statement

This place covers:

Metal forging or pressing methods dedicated to the manufacture of fittings, e.g. lubricant fittings.

Illustrative examples of subject matter classified in this group:

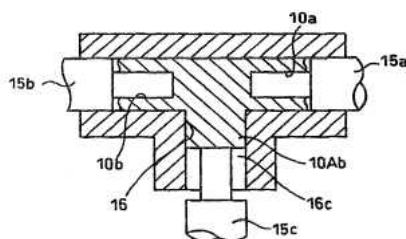

References

Informative references

Attention is drawn to the following places, which may be of interest for search:

Branching pipes	F16L 41/00
-----------------	----------------------------

B21K 1/16

parts of pipe or hose couplings

Definition statement

This place covers:

Metal forging or pressing methods dedicated to the manufacture of parts of pipe or hose couplings.

Illustrative examples of subject matter classified in this group:

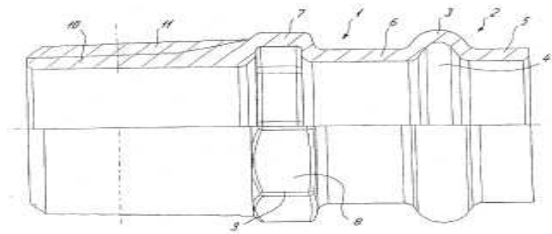

References

Informative references

Attention is drawn to the following places, which may be of interest for search:

Joints, sealing for fuel injection	F02M 55/004
Joints or fitting for pipes	F16L 13/00 - F16L 39/00

B21K 1/18

pistons or plungers

Definition statement

This place covers:

Metal forging or pressing methods dedicated to the manufacture of pistons or plungers.

Illustrative examples of subject matter classified in this group:

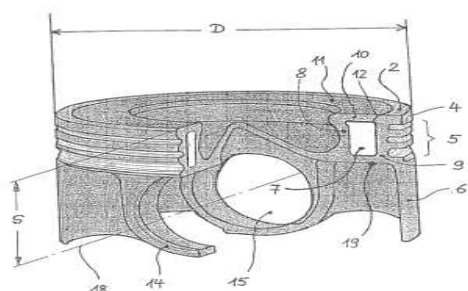

References

Informative references

Attention is drawn to the following places, which may be of interest for search:

Making pistons by operations not covered by any other single subclass	B23P 15/10
Pistons in combustion engines	F02F 3/00
Pistons in general	F16J

B21K 1/20

valve parts

Definition statement

This place covers:

Metal forging or pressing methods dedicated to the manufacture of valve parts.

Illustrative examples of subject matter classified in this group:

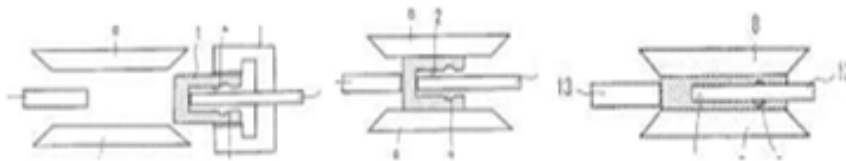

References

Informative references

Attention is drawn to the following places, which may be of interest for search:

Making branched pieces	B21C 37/29
Rotary valves	B62D 5/083

B21K 1/205

{rocker arms}

Definition statement

This place covers:

Metal forging or pressing methods dedicated to the manufacture of rocker arms.

Illustrative examples of subject matter classified in this group:

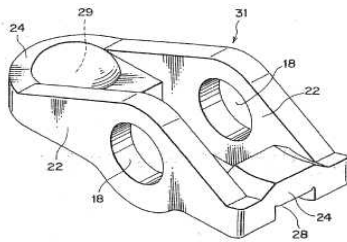

References

Informative references

Attention is drawn to the following places, which may be of interest for search:

Rocking arms or levers	F01L 1/18
------------------------	---------------------------

B21K 1/22

poppet valves, e.g. for internal-combustion engines

Definition statement

This place covers:

Metal forging or pressing methods dedicated to the manufacture of poppet valves, e.g. for internal combustion engines.

Illustrative examples of subject matter classified in this group:

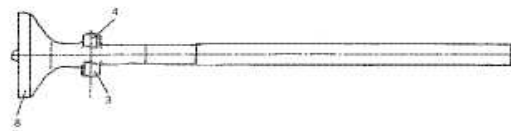

References

Informative references

Attention is drawn to the following places, which may be of interest for search:

Cyclically operating valves	F01L
-----------------------------	----------------------

B21K 1/24

valve bodies; valve seats

Definition statement

This place covers:

Metal forging or pressing methods dedicated to the manufacture of valve bodies or valve seats.

Illustrative examples of subject matter classified in this group:

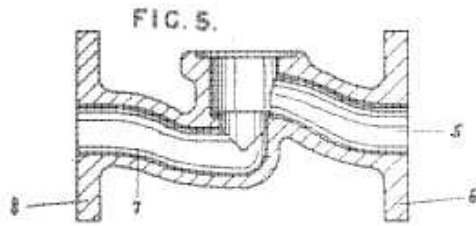

References

Informative references

Attention is drawn to the following places, which may be of interest for search:

Details of fuel injectors	F02M 61/00
Valve housings	F16K 27/00

B21K 1/26

housings or supporting parts, e.g. axle housings, engine mountings

Definition statement

This place covers:

Metal forging or pressing methods dedicated to the manufacture of housings or supporting parts, e.g. axle housings or engine mountings.

Illustrative examples of subject matter classified in this group:

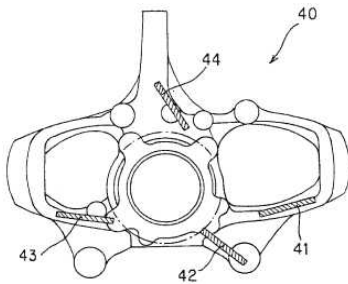

References

Informative references

Attention is drawn to the following places, which may be of interest for search:

Axle housings	B60B 35/16
---------------	----------------------------

B21K 1/28

wheels; discs

Definition statement

This place covers:

Metal forging or pressing methods dedicated to the manufacture of wheels or disks.

References

Informative references

Attention is drawn to the following places, which may be of interest for search:

Vehicle disk wheels	B60B 3/00
---------------------	---------------------------

B21K 1/30

with gear-teeth

Definition statement

This place covers:

Metal forging or pressing methods dedicated to the manufacture of wheels or disks with gear teeth.

Illustrative examples of subject matter classified in this group:

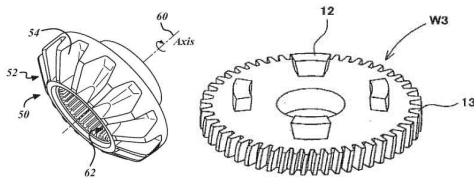

References

Informative references

Attention is drawn to the following places, which may be of interest for search:

Making gear wheels by rolling	B21H 5/00
Making gear parts by operations not covered in any other single subclass	B23P 15/14
Gears with teeth	F16H 55/00

B21K 1/32

discs, e.g. disc wheels

Definition statement

This place covers:

Metal forging or pressing methods dedicated to the manufacture of disks, e.g. disc wheels.

Illustrative examples of subject matter classified in this group:



B21K 1/34

wheels with spokes

Definition statement

This place covers:

Metal forging or pressing methods dedicated to the manufacture of wheels with spokes.

Illustrative examples of subject matter classified in this group:

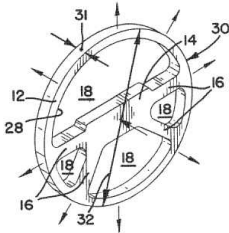

B21K 1/36

with blades

Definition statement

This place covers:

Metal forging or pressing methods dedicated to the manufacture of disks with blades.

Illustrative examples of subject matter classified in this group:



References

Informative references

Attention is drawn to the following places, which may be of interest for search:

Making turbo blades or propellers by extrusion	B21C 23/16
Making turbine wheels by operations not covered in any other single subclass	B23P 15/006
Rotor-blade aggregates	F01D 5/34

B21K 1/38

rims; tyres

Definition statement

This place covers:

Metal forging or pressing methods dedicated to the manufacture of rims or tyres.

Illustrative examples of subject matter classified in this group:



References

Informative references

Attention is drawn to the following places, which may be of interest for search:

Rims per se	B60B 21/00
-------------	----------------------------

B21K 1/40

hubs

Definition statement

This place covers:

Metal forging or pressing methods dedicated to the manufacture of hubs.

Illustrative examples of subject matter classified in this group:

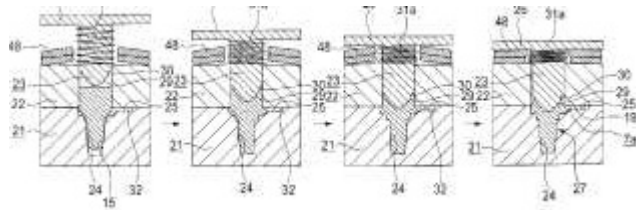

References

Informative references

Attention is drawn to the following places, which may be of interest for search:

Hubs of vehicle wheels	B60B 27/00
------------------------	----------------------------

B21K 1/42

pulleys, e.g. cable pulleys

Definition statement

This place covers:

Metal forging or pressing methods dedicated to the manufacture of pulley, e.g. cable pulleys.

Illustrative examples of subject matter classified in this group:

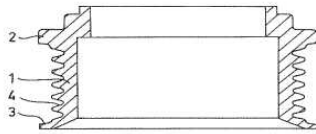

References

Informative references

Attention is drawn to the following places, which may be of interest for search:

Pulleys per se	F16H 55/36
----------------	----------------------------

B21K 1/44

bolts, studs, or the like (making screw-thread [B21K 1/56](#); making U-bolts [B21K 1/74](#))

Definition statement

This place covers:

Metal forging or pressing methods dedicated to the manufacture of bolts studs, or the like.

References

Informative references

Attention is drawn to the following places, which may be of interest for search:

Fasteners	F16B
-----------	----------------------

B21K 1/46

with heads

Definition statement

This place covers:

Metal forging or pressing methods dedicated to the manufacture of heads on bolts studs, or the like.

Illustrative examples of subject matter classified in this group:

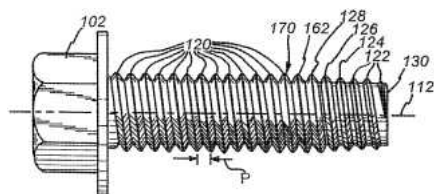

References

Limiting references

This place does not cover:

Forging double ended bolts, studs or the like, i.e. with heads on both ends	B21K 1/52
---	---------------------------

B21K 1/463

{with recessed heads}

Definition statement

This place covers:

Metal forging or pressing methods dedicated to the manufacture of bolts studs, or the like, with recessed heads.

Illustrative examples of subject matter classified in this group:

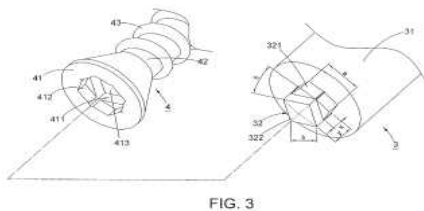

B21K 1/466

{Heading machines with an oscillating die block}

Definition statement

This place covers:

Machines for forge-heading of bolts studs, or the like, and comprising an oscillating die block.

Illustrative examples of subject matter classified in this group:

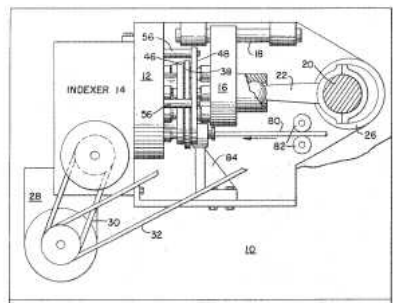

References

Informative references

Attention is drawn to the following places, which may be of interest for search:

Multi-stage forging presses	B21J 9/022
-----------------------------	----------------------------

B21K 1/48

Machines working with hammers, e.g. beating in a radial direction, for forming heads

Definition statement

This place covers:

Machines for forging heads of bolts studs, or the like, and working with hammers, e.g. beating in a radial direction.

References

Limiting references

This place does not cover:

General swaging presses, i.e. beating in radial direction	B21J 9/06
---	---------------------------

B21K 1/50

Trimming or shearing formed heads, e.g. working with dies

Definition statement

This place covers:

Metal forging or pressing methods dedicated to the trimming or shearing of formed heads, e.g. with working dies.

Illustrative examples of subject matter classified in this group:

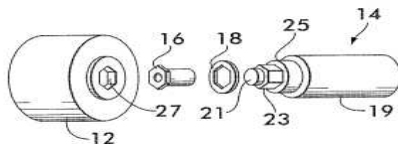

References

Informative references

Attention is drawn to the following places, which may be of interest for search:

Trimming by using dies in general	B21J 5/00
-----------------------------------	---------------------------

B21K 1/52

double-ended, e.g. with heads on both ends (forming heads [B21K 1/46](#))

Definition statement

This place covers:

Metal forging or pressing methods dedicated to the manufacture of double-ended bolts, studs or the like, e.g. with heads on both ends.

Illustrative examples of subject matter classified in this group:

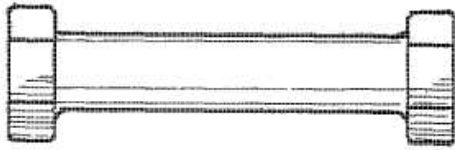

References

Limiting references

This place does not cover:

Forming single heads	B21K 1/46
----------------------	---------------------------

B21K 1/54

with grooves or notches

Definition statement

This place covers:

Metal forging or pressing methods dedicated to the manufacture of bolts, studs, of the like, with grooves or notches.

Illustrative examples of subject matter classified in this group:

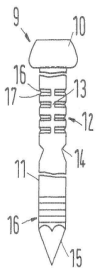

B21K 1/56

screw-threaded elements

Definition statement

This place covers:

Metal forging or pressing methods for forming screw-threads.

Illustrative examples of subject matter classified in this group:

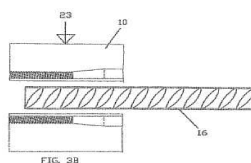

References

Informative references

Attention is drawn to the following places, which may be of interest for search:

Forming screw threads by rolling	B21H 3/00
----------------------------------	---------------------------

B21K 1/58

rivets

Definition statement

This place covers:

Metal forging or pressing methods dedicated to the manufacture of rivets.

References

Informative references

Attention is drawn to the following places, which may be of interest for search:

Rivets	F16B 19/04
--------	----------------------------

B21K 1/60

hollow or semi-hollow rivets

Definition statement

This place covers:

Metal forging or pressing methods dedicated to the manufacture of hollow or semi-hollow rivets.

Illustrative examples of subject matter classified in this group:



References

Informative references

Attention is drawn to the following places, which may be of interest for search:

Hollow rivets	F16B 19/08
---------------	----------------------------

B21K 1/62

special rivets, e.g. with electrical contacts

Definition statement

This place covers:

Metal forging or pressing methods dedicated to the manufacture of special rivets, e.g. with electrical contacts.

Illustrative examples of subject matter classified in this group:

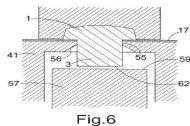

References

Informative references

Attention is drawn to the following places, which may be of interest for search:

Rivets	F16B 19/04
Manufacture of electric switches	H01H 11/00

B21K 1/64

nuts (making screw-thread [B21K 1/56](#))

Definition statement

This place covers:

Metal forging or pressing methods dedicated to the manufacture of nuts.

References

Informative references

Attention is drawn to the following places, which may be of interest for search:

Pressing nuts from metal sheet without substantially modifying the metal sheet thickness	B21D 53/24
Nuts	F16B 37/00

B21K 1/66

from strip bars

Definition statement

This place covers:

Metal forging or pressing methods dedicated to the manufacture of nuts from strip bars.

Illustrative examples of subject matter classified in this group:

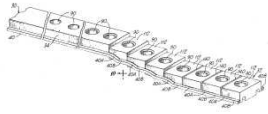

B21K 1/68

from round or profiled bars

Definition statement

This place covers:

Metal forging or pressing methods dedicated to the manufacture of nuts from round or profiled bars.

Illustrative examples of subject matter classified in this group:

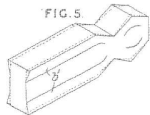

B21K 1/70

of special shape, e.g. self-locking nuts, wing nuts

Definition statement

This place covers:

Metal forging or pressing methods dedicated to the manufacture of nuts of special shape, e.g. self-locking nuts, wing nuts.

B21K 1/701

{Weld nuts}

Definition statement

This place covers:

Metal forging or pressing methods dedicated to the manufacture of weld nuts.

Illustrative examples of subject matter classified in this group:

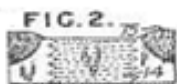

References

Informative references

Attention is drawn to the following places, which may be of interest for search:

Weld nuts	F16B 37/061
-----------	-----------------------------

B21K 1/702

{Clinch nuts}

Definition statement

This place covers:

Metal forging or pressing methods dedicated to the manufacture of clinch nuts.

Illustrative examples of subject matter classified in this group:

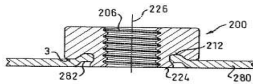

References

Informative references

Attention is drawn to the following places, which may be of interest for search:

Setting pierce-nuts	B23P 19/062
Nuts deforming the material of the support	F16B 37/068

B21K 1/704

{Cap nuts}

Definition statement

This place covers:

Metal forging or pressing methods dedicated to the manufacture of cap nuts.

Illustrative examples of subject matter classified in this group:

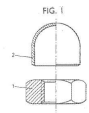

References

Informative references

Attention is drawn to the following places, which may be of interest for search:

Cap nuts	F16B 37/14
----------	----------------------------

B21K 1/705

{Castellated nuts}

Definition statement

This place covers:

Metal forging or pressing methods dedicated to the manufacture of castellated nuts.

Illustrative examples of subject matter classified in this group:



References

Informative references

Attention is drawn to the following places, which may be of interest for search:

Locking of nuts with a member penetrating the screw-threaded surface	F16B 39/04
--	----------------------------

B21K 1/707

{Self-locking nuts}

Definition statement

This place covers:

Metal forging or pressing methods dedicated to the manufacture of self-locking nuts.

Illustrative examples of subject matter classified in this group:



References

Informative references

Attention is drawn to the following places, which may be of interest for search:

Locking of nuts provided with locking members	F16B 39/28
---	----------------------------

B21K 1/708

{wing nuts}

Definition statement

This place covers:

Metal forging or pressing methods dedicated to the manufacture of wing nuts.

Illustrative examples of subject matter classified in this group:



References

Informative references

Attention is drawn to the following places, which may be of interest for search:

Wing nuts	F16B 37/16
-----------	----------------------------

B21K 1/72

hooks, e.g. crane hooks, railway track spikes (making nails in general [B21G](#))

Definition statement

This place covers:

Metal forging or pressing methods dedicated to the manufacture of hooks, e.g. crane hooks, railway track spikes.

Illustrative examples of subject matter classified in this group:

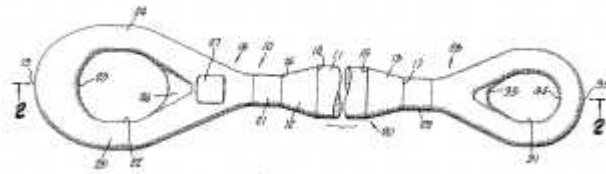

References

Limiting references

This place does not cover:

Making nails in general	B21G
-------------------------	----------------------

B21K 1/74

forked members or members with two or more limbs, e.g. U-bolts, anchors

Definition statement

This place covers:

Metal forging or pressing methods dedicated to the manufacture of forked members or members with two or more limbs, e.g. U-bolts, anchors.

Definition statement

Illustrative examples of subject matter classified in this group:

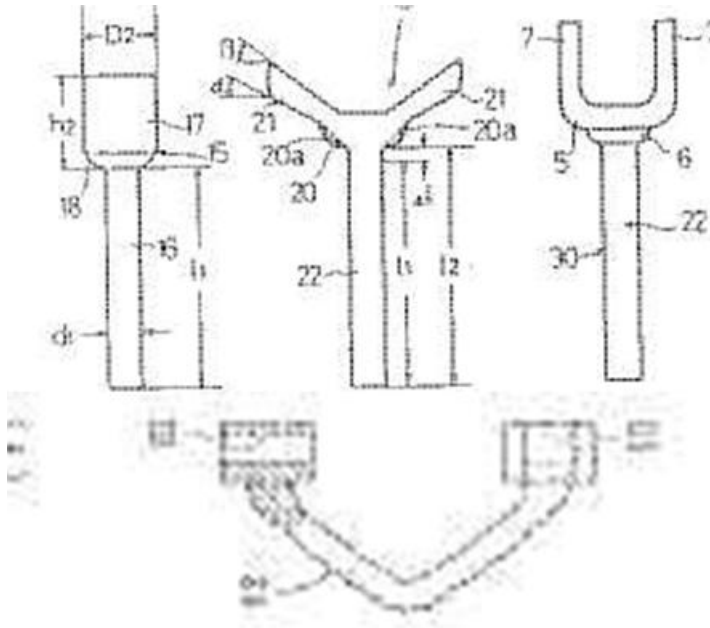

B21K 1/76

elements not mentioned in one of the preceding groups

Definition statement

This place covers:

Metal forging or pressing methods dedicated to the manufacture of machine elements not mentioned in one of the preceding groups.

References

References out of a residual place

Examples of places in relation to which this place is residual:

Making engine or like machine parts	B21K 3/00
Making tools or tool parts	B21K 5/00
Making railway appurtenances; vehicle parts	B21K 7/00
Reconditioning railroad accessories	B21K 9/00
Making cutlery wares; garden tools	B21K 11/00
Making locksmith's goods	B21K 13/00
Making blacksmith's goods	B21K 15/00
Making sport articles	B21K 17/00
Making articles for agricultural machinery	B21K 19/00
Making hollow articles not covered by a single preceding group	B21K 21/00
Making other articles	B21K 23/00
Uniting components to form integral members	B21K 25/00

B21K 1/761**{rings}****Definition statement***This place covers:*

Metal forging or pressing methods dedicated to the manufacture of rings.

Illustrative examples of subject matter classified in this group:

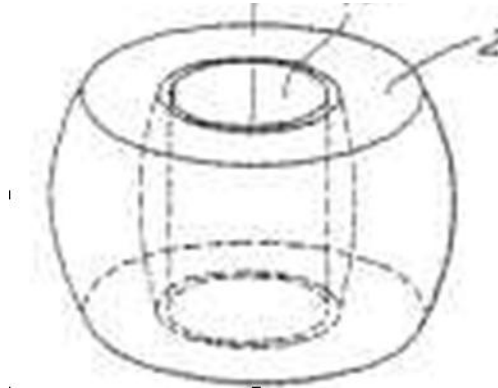
**B21K 1/762****{Coupling members for conveying mechanical motion, e.g. universal joints}****Definition statement***This place covers:*

Metal forging or pressing methods dedicated to the manufacture of coupling members for conveying mechanical motion, e.g. universal joints.

Illustrative examples of subject matter classified in this group:

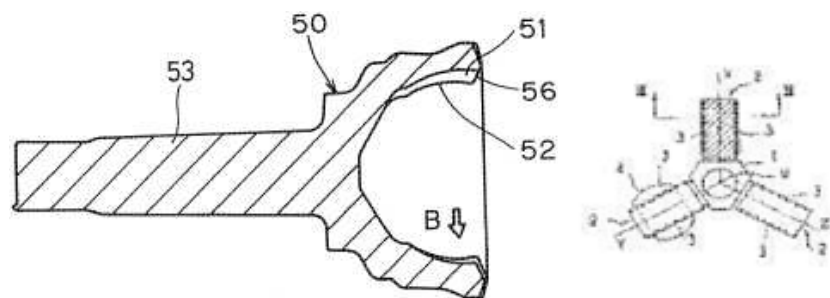
**References****Informative references***Attention is drawn to the following places, which may be of interest for search:*

Ball joints	F16C 11/06
Universal joints	F16D 3/16

B21K 1/766**{Connecting rods}****Definition statement**

This place covers:

Metal forging or pressing methods dedicated to the manufacture of connecting rods.

Illustrative examples of subject matter classified in this group:

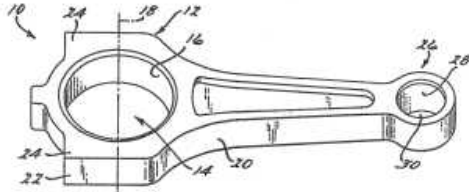
**References****Informative references**

Attention is drawn to the following places, which may be of interest for search:

Connecting rods	F16C 7/00
-----------------	---------------------------

B21K 1/767**{Toothed racks}****Definition statement**

This place covers:

Metal forging or pressing methods dedicated to the manufacture of toothed racks.

Illustrative examples of subject matter classified in this group:

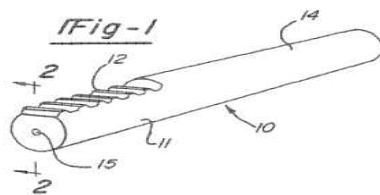
**References****Informative references**

Attention is drawn to the following places, which may be of interest for search:

Rack and pinion steering gears	B62D 3/12
Racks	F16H 55/26

B21K 3/00

**Making engine or like machine parts not covered by sub-groups of [B21K 1/00](#);
Making propellers or the like**

Definition statement

This place covers:

Metal forging or pressing methods dedicated to the manufacture of engine or machine parts, e.g. propellers, magnet wheel disks, scrolls for air conditioners.

Illustrative examples of subject matter classified in this group:

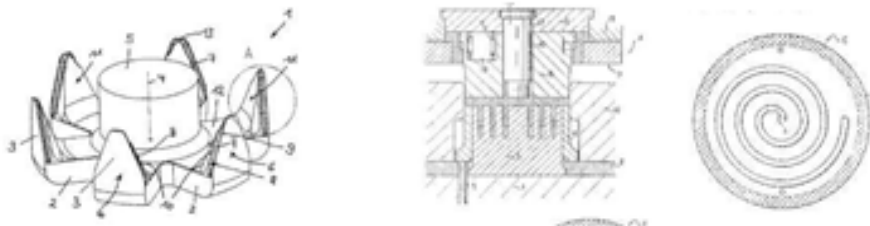

References

Limiting references

This place does not cover:

Making machine elements	B21K 1/00
Making machine elements not specified elsewhere	B21K 1/76

Informative references

Attention is drawn to the following places, which may be of interest for search:

Air conditioning	F24F
Dynamo electric machines	H02K

B21K 3/02

cylinder heads

Definition statement

This place covers:

Metal forging or pressing methods dedicated to the manufacture of cylinder heads.

Illustrative examples of subject matter classified in this group:

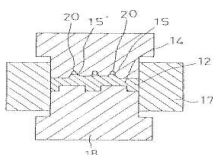

References

Informative references

Attention is drawn to the following places, which may be of interest for search:

Cylinder heads	F02F 1/24
----------------	---------------------------

B21K 3/04

blades, e.g. for turbines; Upsetting of blade roots

Definition statement

This place covers:

Metal forging, pressing or upsetting methods dedicated to the manufacture of blades, e.g. for turbines.

Illustrative examples of subject matter classified in this group:

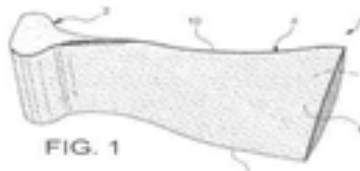

References

Informative references

Attention is drawn to the following places, which may be of interest for search:

Making turbine or like blades by operations not covered in any other single subclass	B23P 15/02
Blades of non positive displacement machines	F01D 5/12

B21K 5/00

Making tools or tool parts, e.g. pliers

Definition statement

This place covers:

Metal forging or pressing methods dedicated to the manufacture of tools or tool parts, a non-limiting example being pliers.

B21K 5/02

drilling-tools or other for making or working on holes

Definition statement

This place covers:

Metal forging or pressing methods dedicated to the manufacture of drilling tools or other for making or working on holes.

References

Informative references

Attention is drawn to the following places, which may be of interest for search:

Metal drilling tools	B23B 51/00
Wood boring or turning tools	B27G 15/00
Earth drilling bits	E21B 10/00

B21K 5/04

twisting-tools, e.g. drills, reamers

Definition statement

This place covers:

Metal forging or pressing methods dedicated to the manufacture of twisting tools, e.g. drills, reamers.

Illustrative examples of subject matter classified in this group:

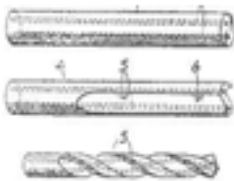

References

Informative references

Attention is drawn to the following places, which may be of interest for search:

Dentistry root canal files	A61C 5/42
Tools for drilling machines	B23B 51/00
Wood boring or turning tools	B27G 15/00

B21K 5/06

Dressing, e.g. sharpening rock drills

Definition statement

This place covers:

Metal forging or pressing methods dedicated to the manufacture of dressing, e.g. sharpening rock drills.

Definition statement

Illustrative examples of subject matter classified in this group:

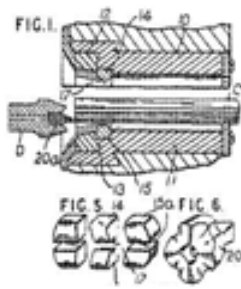

B21K 5/08

drifting tools

Definition statement

This place covers:

Metal forging or pressing methods dedicated to the manufacture of drifting tools.

Remark: this subgroup is empty.

B21K 5/10

Forming drill-bit shanks

Definition statement

This place covers:

Metal forging or pressing methods dedicated to the manufacture of drill-bit shanks.

Illustrative examples of subject matter classified in this group:

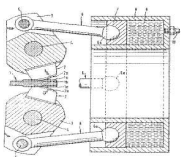

References

Informative references

Attention is drawn to the following places, which may be of interest for search:

Chucks and tool shanks	B23B 2231/00
Tools or bench devices not otherwise provided for	B25B

B21K 5/12

other cutting tools (cutlery wares [B21K 11/00](#))

Definition statement

This place covers:

Metal forging or pressing methods dedicated to the manufacture of other cutting tools, e.g. chisels, saw blades, chopping blades, nippers, etc.

Illustrative examples of subject matter classified in this group:

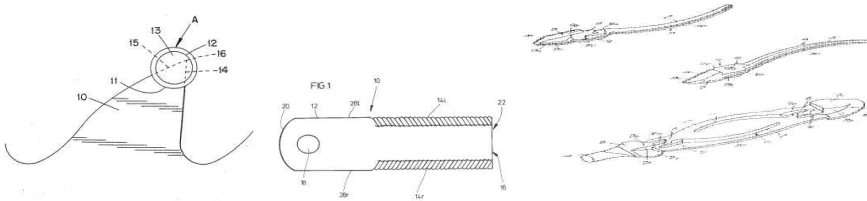

References

Limiting references

This place does not cover:

Forging cutlery wares	B21K 11/00
-----------------------	----------------------------

Informative references

Attention is drawn to the following places, which may be of interest for search:

Cutting stones	B28D 1/00
Mining picks	E21C 35/18

B21K 5/14

hand hammers

Definition statement

This place covers:

Metal forging or pressing methods dedicated to the manufacture of hand hammers.

References

Informative references

Attention is drawn to the following places, which may be of interest for search:

Hand hammers	B25D 1/00
--------------	---------------------------

B21K 5/16**tools for turning nuts****Definition statement**

This place covers:

Metal forging or pressing methods dedicated to the manufacture of tool for turning nuts.

Illustrative examples of subject matter classified in this group:

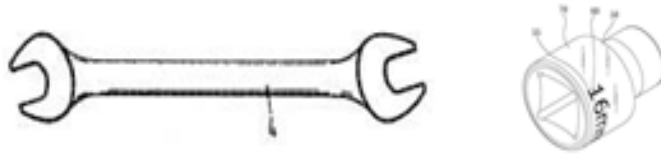
**References****Informative references**

Attention is drawn to the following places, which may be of interest for search:

Spanners, wrenches	B25B 13/00
--------------------	----------------------------

B21K 5/18**handles or parts therefor****Definition statement**

This place covers:

Metal forging or pressing methods dedicated to the manufacture of handtools or parts therefor.

References**Informative references**

Attention is drawn to the following places, which may be of interest for search:

Surgical scalpels with detachable blade	A61B 17/3213
---	------------------------------

B21K 5/20**Making working faces of dies, either recessed or outstanding****Definition statement**

This place covers:

Metal forging or pressing methods dedicated to the manufacture of working faces of dies, either recessed or outstanding.

Illustrative examples of subject matter classified in this group:

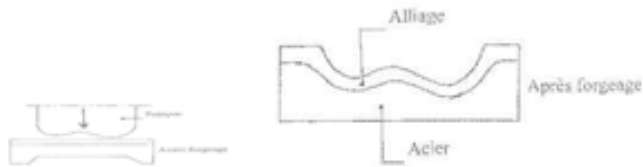

References

Informative references

Attention is drawn to the following places, which may be of interest for search:

Metal forging dies	B21J 13/02
Making dies by operations not covered in any other single subclass	B23P 15/24
Dies for working of plastic material	B29C

B21K 7/00

Making railway appurtenances; Making vehicle parts

Definition statement

This place covers:

Metal forging or pressing methods dedicated to the manufacture of railway appurtenances or vehicle parts.

References

Informative references

Attention is drawn to the following places, which may be of interest for search:

Making machine elements	B21K 1/00
Making engine or like machine parts	B21K 3/00

B21K 7/02

parts for permanent way (spikes [B21K 1/72](#))

Definition statement

This place covers:

Metal forging or pressing methods dedicated to the manufacture of parts for permanent way.

Illustrative examples of subject matter classified in this group:

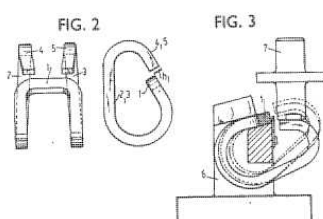

References

Limiting references

This place does not cover:

Forging spikes	B21K 1/72
----------------	---------------------------

B21K 7/04

switch tongues

Definition statement

This place covers:

Metal forging or pressing methods dedicated to the manufacture of switch tongues.

B21K 7/06

sleepers

Definition statement

This place covers:

Metal forging or pressing methods dedicated to the manufacture of sleepers.

B21K 7/08

base plates for rails, e.g. chairs

Definition statement

This place covers:

Metal forging or pressing methods dedicated to the manufacture of base plates for rails, e.g. chairs.

B21K 7/10

rails joints

Definition statement

This place covers:

Metal forging or pressing methods dedicated to the manufacture of rails joints.

B21K 7/12

parts for locomotives or vehicles, e.g. frames, underframes

Definition statement

This place covers:

Metal forging or pressing methods dedicated to the manufacture of parts for locomotives or vehicles, e.g. frames, underframes.

B21K 7/14

brake rigging or brake parts

Definition statement

This place covers:

Metal forging or pressing methods dedicated to the manufacture of brake rigging or brake parts.

B21K 9/00

Reconditioning railroad accessories, e.g. rails

Definition statement

This place covers:

Metal forging or pressing methods dedicated to the reconditioning of railroad accessories, e.g. rails.

Illustrative examples of subject matter classified in this group:

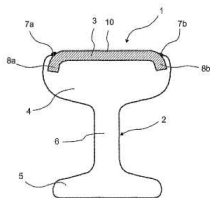

References

Informative references

Attention is drawn to the following places, which may be of interest for search:

Composite power rails	B60M 1/302
Composite rails	E01B 5/08

B21K 11/00

Making cutlery wares; Making garden tools or the like

Definition statement

This place covers:

Metal forging or pressing methods dedicated to the manufacture of cutlery wares or garden tools. The expression "or the like" is to be ignored.

B21K 11/02

knives

Definition statement

This place covers:

Metal forging or pressing methods dedicated to the manufacture of knives.

B21K 11/04**spoons; table forks****Definition statement***This place covers:*

Metal forging or pressing methods dedicated to the manufacture of spoons or table forks.

B21K 11/06**scissors****Definition statement***This place covers:*

Metal forging or pressing methods dedicated to the manufacture of scissors.

B21K 11/08**sickles; scythes****Definition statement***This place covers:*

Metal forging or pressing methods dedicated to the manufacture of sickles or scythes.

B21K 11/10**axes; picks****Definition statement***This place covers:*

Metal forging or pressing methods dedicated to the manufacture of axes or picks.

Illustrative examples of subject matter classified in this group:

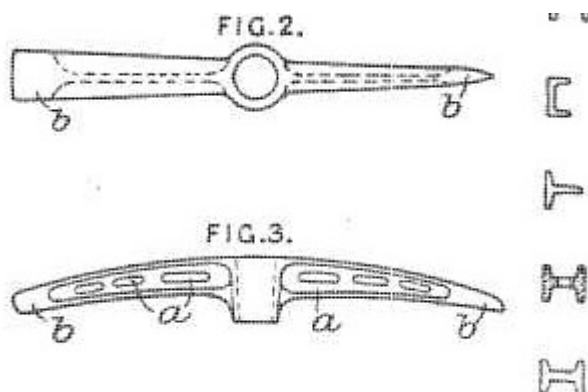

B21K 11/12

spades; shovels

Definition statement

This place covers:

Metal forging or pressing methods dedicated to the manufacture of spades or shovels.

Illustrative examples of subject matter classified in this group:

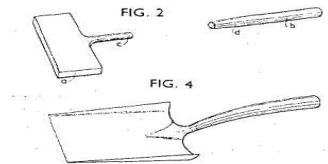

B21K 11/14

rakes; garden forks

Definition statement

This place covers:

Metal forging or pressing methods dedicated to the manufacture of rakes or garden forks.

Illustrative examples of subject matter classified in this group:

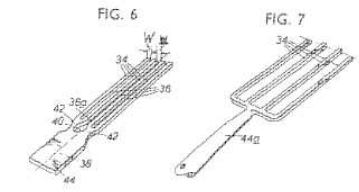

B21K 13/00

Making locksmiths' goods, e.g. handles for cases

Definition statement

This place covers:

Metal forging or pressing methods dedicated to the manufacture of locksmiths' goods, e.g. handles for cases.

References

Informative references

Attention is drawn to the following places, which may be of interest for search:

Details of locks	E05B 15/00
------------------	----------------------------

B21K 13/02

hinges

Definition statement

This place covers:

Metal forging or pressing methods dedicated to the manufacture of hinges.

Illustrative examples of subject matter classified in this group:

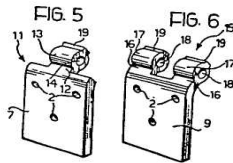

References

Informative references

Attention is drawn to the following places, which may be of interest for search:

Construction of hinges	E05D 5/00
------------------------	---------------------------

B21K 15/00

Making blacksmiths' goods

Definition statement

This place covers:

Metal forging or pressing methods dedicated to the manufacture of blacksmith's goods.

B21K 15/02

horseshoes; appurtenances therefor

Definition statement

This place covers:

Metal forging or pressing methods dedicated to the manufacture of horseshoes or appurtenances therefor.

Illustrative examples of subject matter classified in this group:

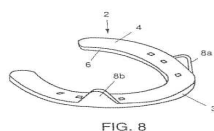

References

Informative references

Attention is drawn to the following places, which may be of interest for search:

Shoeing of animals	A01L
--------------------	----------------------

B21K 15/04

caulks

Definition statement

This place covers:

Metal forging or pressing methods dedicated to the manufacture of caulks

Illustrative examples of subject matter classified in this group:

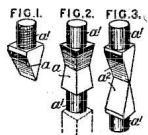

B21K 15/06

metal attachments for footwear, e.g. wearresisting plates

Definition statement

This place covers:

Metal forging or pressing methods dedicated to the manufacture of metal attachments for footwear, e.g. wear-resisting plates.

B21K 17/00

Making sport articles, e.g. skates

Definition statement

This place covers:

Metal forging or pressing methods dedicated to the manufacture of sports articles, e.g. skates or golf clubs.

Illustrative examples of subject matter classified in this group:

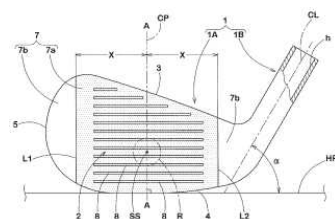

References

Informative references

Attention is drawn to the following places, which may be of interest for search:

Golf clubs	A63B 53/00
------------	----------------------------

B21K 19/00

Making articles for agricultural machinery

Definition statement

This place covers:

Metal forging or pressing methods dedicated to the manufacture of articles for agricultural machinery

Illustrative examples of subject matter classified in this group:

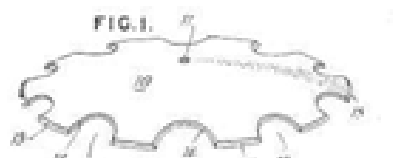

References

Informative references

Attention is drawn to the following places, which may be of interest for search:

Dredging, soil-shifting	E02F
-------------------------	----------------------

B21K 19/02

plough blades; ploughshares

Definition statement

This place covers:

Metal forging or pressing methods dedicated to the manufacture of plough blades or ploughshares.

B21K 21/00

Making hollow articles not covered by a single preceding sub-group (essentially from sheet-metal or uniform thin-walled tubes [B21D](#), e.g. [B21D 41/00](#), [B21D 51/00](#))

Definition statement

This place covers:

Metal forging or pressing methods dedicated to the manufacture of hollow articles.

B21K 21/02

Producing blanks in the shape of discs or cups as semifinished articles for making hollow articles, e.g. to be deep-drawn or extruded

Definition statement

This place covers:

Metal forging or pressing methods dedicated to the manufacture of discs or cups as semi-finished articles.

Illustrative examples of subject matter classified in this group:

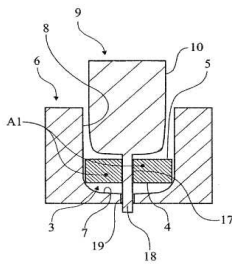

B21K 21/04

Shaping thin-walled hollow articles, e.g. cartridges

Definition statement

This place covers:

Metal forging or pressing methods dedicated to the manufacture of cartridges.

Illustrative examples of subject matter classified in this group:

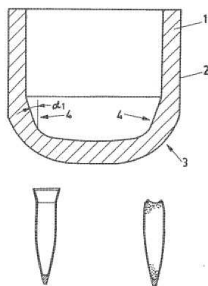

References

Informative references

Attention is drawn to the following places, which may be of interest for search:

Cartridge ammunition	F42B 5/00
----------------------	---------------------------

B21K 21/06

Shaping thick-walled hollow articles, e.g. projectiles

Definition statement

This place covers:

Metal forging or pressing methods dedicated to the manufacture of thick-walled hollow articles, e.g. projectiles.

Illustrative examples of subject matter classified in this group:

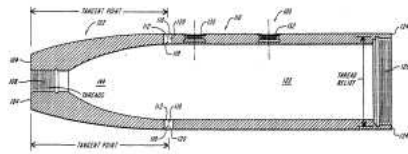

References

Informative references

Attention is drawn to the following places, which may be of interest for search:

Projectiles, missiles	F42B 12/00
-----------------------	----------------------------

B21K 21/08

Shaping hollow articles with different cross-section in longitudinal direction, e.g. nozzles, spark-plugs

Definition statement

This place covers:

Metal forging or pressing methods dedicated to the manufacture of hollow articles with different cross-section, e.g. nozzles, spark-plugs.

Illustrative examples of subject matter classified in this group:

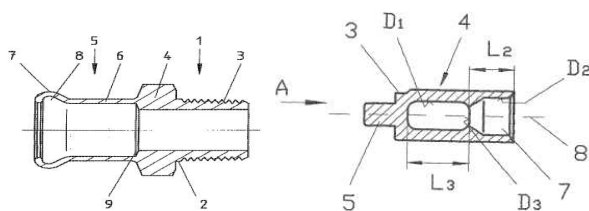

References

Informative references

Attention is drawn to the following places, which may be of interest for search:

Spark plugs	H01T 21/02
-------------	----------------------------

B21K 21/10

cone-shaped or bell-shaped articles, e.g. insulator caps

Definition statement

This place covers:

Metal forging or pressing methods dedicated to the manufacture of cone-shaped or bell-shaped articles, e.g. insulator caps.

Illustrative examples of subject matter classified in this group:

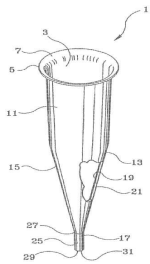

References

Informative references

Attention is drawn to the following places, which may be of interest for search:

Electric terminals	H01M 50/543
--------------------	-----------------------------

B21K 21/12

Shaping end portions of hollow articles

Definition statement

This place covers:

Metal forging or pressing methods dedicated to the shaping of end-portions of hollow articles.

Illustrative examples of subject matter classified in this group:

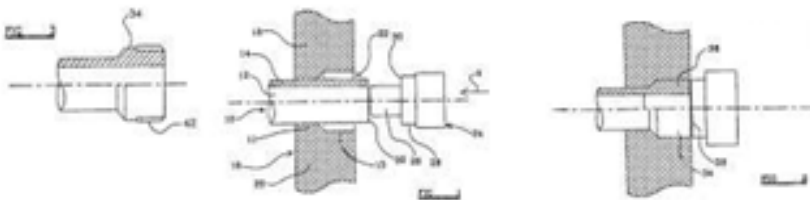

References

Limiting references

This place does not cover:

Making flanged articles	B21K 23/04
-------------------------	----------------------------

Informative references

Attention is drawn to the following places, which may be of interest for search:

Shaping end portions of hollow articles without substantially modifying the workpiece thickness	B21D 41/04
---	----------------------------

B21K 21/14

closed or substantially-closed ends, e.g. cartridge bottoms

Definition statement

This place covers:

Metal forging or pressing methods dedicated to the shaping of closed or substantially closed end- portions of hollow articles, e.g. cartridge bottoms.

Illustrative examples of subject matter classified in this group:

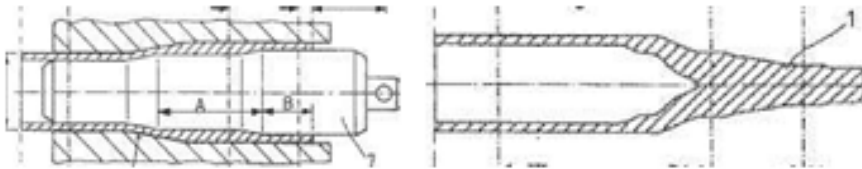
**References****Informative references**

Attention is drawn to the following places, which may be of interest for search:

Closing end portions of hollow articles without substantially modifying the workpiece thickness	B21D 41/045
---	-----------------------------

B21K 21/16

**Remodelling hollow bodies with respect to the shape of the cross-section
(remodelling end portions only [B21K 21/12](#))**

Definition statement

This place covers:

Metal forging or pressing methods dedicated to the remodelling of hollow bodies with respect to the shape of their cross-section.

Illustrative examples of subject matter classified in this group:

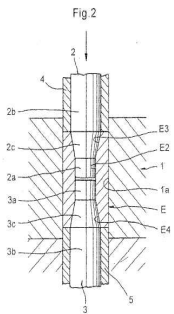

References

Limiting references

This place does not cover:

Remodelling end-portions only	B21K 21/12
-------------------------------	----------------------------

B21K 23/00

Making other articles

Definition statement

This place covers:

Metal forging or pressing methods dedicated to the manufacture of articles not provided for in the groups [B21K 1/00](#) - [B21K 21/00](#), especially thin articles worked in their thickness.

Illustrative examples of subject matter classified in this group:

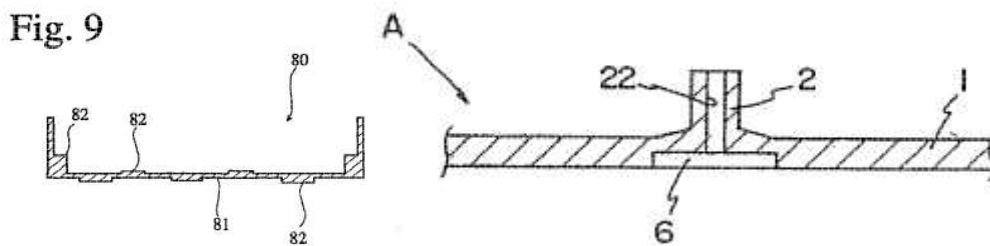

Source: EP0945199, WO2006008861.

References

Limiting references

This place does not cover:

Making machine elements	B21K 1/00
Making other machine elements	B21K 1/76
Making other engine or machine parts	B21K 3/00

B21K 23/02

members of endless tracks, e.g. track guides, shoes (making from sheet-metal [B21D](#))

Definition statement

This place covers:

Metal forging or pressing methods dedicated to the manufacture of members of endless tracks, e.g. track guides, shoes.

Illustrative examples of subject matter classified in this group:

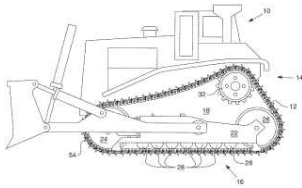

References

Informative references

Attention is drawn to the following places, which may be of interest for search:

Making roller chains	B21L 9/02
Endless track vehicles	B62D 55/00

B21K 23/04

flanged articles ([B21K 1/28](#) takes precedence; flanging tubes [B21D](#))

Definition statement

This place covers:

Metal forging or pressing methods dedicated to the manufacture of flanged articles.

Illustrative examples of subject matter classified in this group:

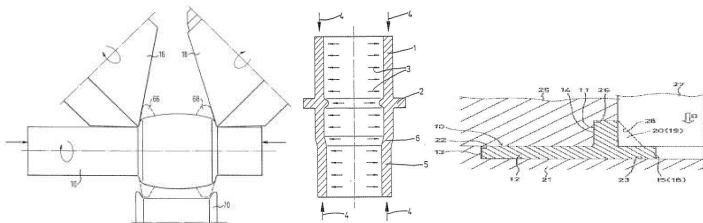

Relationships with other classification places

Flanging tubes without substantially modifying the tube thickness	B21D
---	----------------------

References

Limiting references

This place does not cover:

Making wheel, disks	B21K 1/28
Shaping end-portions of hollow articles	B21K 21/12

B21K 25/00

Uniting components to form integral members, e.g. turbine wheels and shafts, caulks with inserts, with or without shaping of the components (uniting by interference- or press-fitting [B23P 11/02](#), [B21K 19/02](#))

Definition statement

This place covers:

Metal forging or pressing methods for uniting components in order to form integral members, with or without shaping the components.

Illustrative examples of subject matter classified in this group:

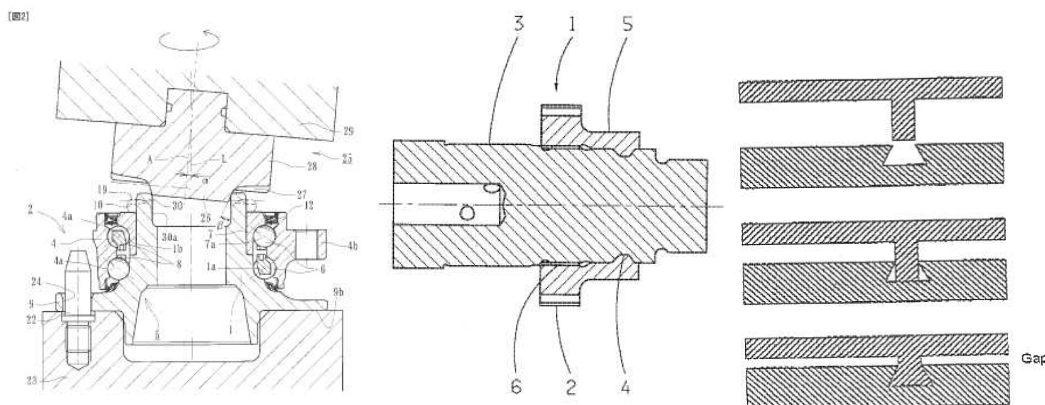

Relationships with other classification places

Interference or press-fitting	B23P 11/02
Uniting metal sheets by deformation	B21D 39/03
Press-welding by means or rolling mills	B23K 20/04

References

Limiting references

This place does not cover:

Riveting	B21J 15/00
----------	----------------------------

B21K 25/005

{by friction heat forging ([B21J 15/027](#) takes precedence; friction heat forging per se [B21J 5/063](#))}

Definition statement

This place covers:

Metal forging or pressing methods dedicated to uniting components by friction heat forging.

Illustrative examples of subject matter classified in this group:

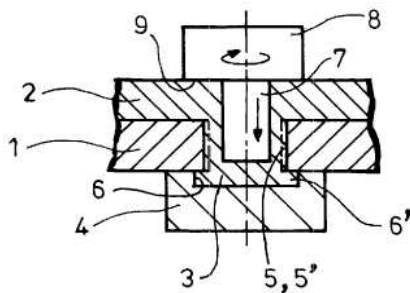

References

Limiting references

This place does not cover:

Friction heat riveting	B21J 15/027
------------------------	-----------------------------

Informative references

Attention is drawn to the following places, which may be of interest for search:

Friction heat forging per se	B21J 5/063
------------------------------	----------------------------

B21K 27/00

Handling devices, e.g. for feeding, aligning, discharging, Cutting-off means; Arrangement thereof

Definition statement

This place covers:

Handling devices in relation to metal forging or pressing, for e.g. feeding, aligning, discharging, cutting off.

References

Limiting references

This place does not cover:

Accessories for handling forging work	B21J 13/08
---------------------------------------	----------------------------

B21K 27/02

Feeding devices for rods, wire, or strips

Definition statement

This place covers:

Devices for feeding rods, wires or strips into a forging machine.

Illustrative examples of subject matter classified in this group:

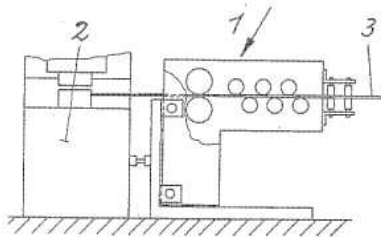

B21K 27/04

allowing successive working steps

Definition statement

This place covers:

Devices for feeding and allowing successive working steps.

Illustrative examples of subject matter classified in this group:

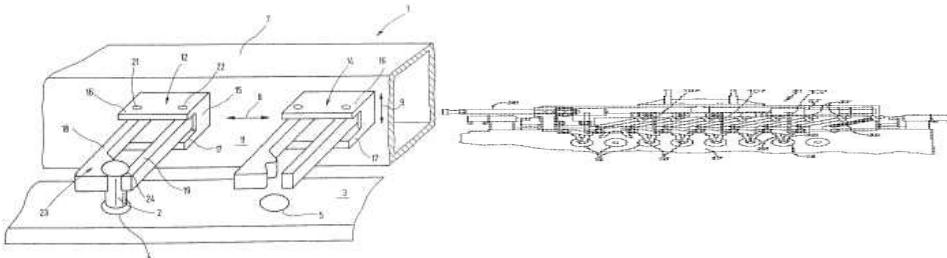

References

Informative references

Attention is drawn to the following places, which may be of interest for search:

Multiple die presses	B21J 9/022
----------------------	----------------------------

B21K 27/06

Cutting-off means; Arrangements thereof

Definition statement

This place covers:

Means for cutting-off forging material.

Illustrative examples of subject matter classified in this group:

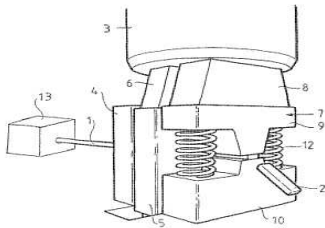

References

Informative references

Attention is drawn to the following places, which may be of interest for search:

Cutting metal in general	B23D
--------------------------	----------------------

B21K 29/00

Arrangements for heating or cooling during processing (for preparing metal stock to be forged or pressed [B21J 1/06](#); heating equipment per se, see the appropriate classes, e.g. [H05B](#))

Definition statement

This place covers:

Arrangements for heating or cooling during forging.

Illustrative examples of subject matter classified in this group:

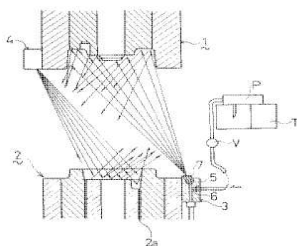

References

Informative references

Attention is drawn to the following places, which may be of interest for search:

Heating processes before forging	B21J 1/06
Heating equipment per se	H05B

B21K 31/00

Control devices specially adapted for positioning tool carriers

Definition statement

This place covers:

Control devices specially adapted for positioning tool carriers.

Illustrative examples of subject matter classified in this group:

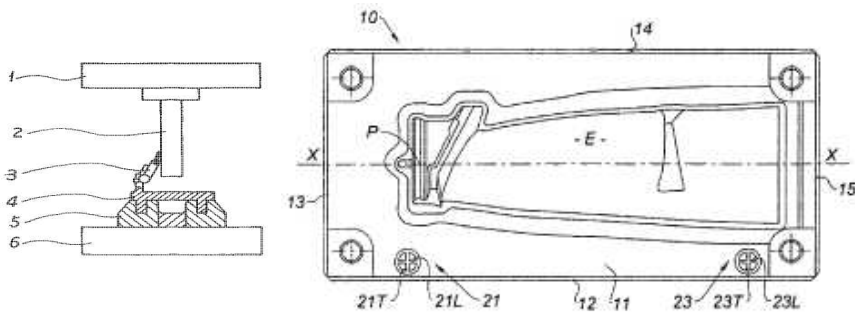

References

Informative references

Attention is drawn to the following places, which may be of interest for search:

Die mountings	B21J 13/03
---------------	----------------------------